

# Cortex-M4

Revision r0p0

## Technical Reference Manual



# Cortex-M4

## Technical Reference Manual

Copyright © 2009, 2010 ARM Limited. All rights reserved.

### Release Information

The following changes have been made to this book.

Change History			
Date	Issue	Confidentiality	Change
22 December 2009	A	Non-Confidential, Restricted Access	First release for r0p0
02 March 2010	B	Non-Confidential	Second release for r0p0

### Proprietary Notice

Words and logos marked with ® or ™ are registered trademarks or trademarks of ARM® Limited in the EU and other countries, except as otherwise stated in this proprietary notice. Other brands and names mentioned herein may be the trademarks of their respective owners.

Neither the whole nor any part of the information contained in, or the product described in, this document may be adapted or reproduced in any material form except with the prior written permission of the copyright holder.

The product described in this document is subject to continuous developments and improvements. All particulars of the product and its use contained in this document are given by ARM Limited in good faith. However, all warranties implied or expressed, including but not limited to implied warranties of merchantability, or fitness for purpose, are excluded.

This document is intended only to assist the reader in the use of the product. ARM Limited shall not be liable for any loss or damage arising from the use of any information in this document, or any error or omission in such information, or any incorrect use of the product.

Where the term ARM is used it means “ARM or any of its subsidiaries as appropriate”.

Some material in this document is based on IEEE 754-2008 IEEE Standard for Binary Floating-Point Arithmetic. The IEEE disclaims any responsibility or liability resulting from the placement and use in the described manner.

### Confidentiality Status

This document is Non-Confidential. The right to use, copy and disclose this document may be subject to license restrictions in accordance with the terms of the agreement entered into by ARM and the party that ARM delivered this document to.

Unrestricted Access is an ARM internal classification.

### Product Status

The information in this document is Final (information on a developed product).

### Web Address

<http://www.arm.com>

# Contents

## Cortex-M4 Technical Reference Manual

	<b>Preface</b>	
	About this book .....	ix
	Feedback .....	xi
<b>Chapter 1</b>	<b>Introduction</b>	
	1.1 About the processor .....	1-2
	1.2 Features .....	1-3
	1.3 Interfaces .....	1-4
	1.4 Configurable options .....	1-5
	1.5 Product documentation .....	1-6
<b>Chapter 2</b>	<b>Functional Description</b>	
	2.1 About the functions .....	2-2
	2.2 Interfaces .....	2-5
<b>Chapter 3</b>	<b>Programmers Model</b>	
	3.1 About the programmers model .....	3-2
	3.2 Modes of operation and execution .....	3-3
	3.3 Instruction set summary .....	3-4
	3.4 System address map .....	3-14
	3.5 Write buffer .....	3-17
	3.6 Exclusive monitor .....	3-18
	3.7 Bit-banding .....	3-19
	3.8 Processor core register summary .....	3-21
	3.9 Exceptions .....	3-23
<b>Chapter 4</b>	<b>System Control</b>	
	4.1 About system control .....	4-2

	4.2	Register summary .....	4-3
	4.3	Register descriptions .....	4-5
<b>Chapter 5</b>		<b>Memory Protection Unit</b>	
	5.1	About the MPU .....	5-2
	5.2	MPU functional description .....	5-3
	5.3	MPU programmers model .....	5-4
<b>Chapter 6</b>		<b>Nested Vectored Interrupt Controller</b>	
	6.1	About the NVIC .....	6-2
	6.2	NVIC functional description .....	6-3
	6.3	NVIC programmers model .....	6-4
<b>Chapter 7</b>		<b>Floating Point Unit</b>	
	7.1	About the FPU .....	7-2
	7.2	FPU Functional Description .....	7-3
	7.3	FPU Programmers Model .....	7-9
<b>Chapter 8</b>		<b>Debug</b>	
	8.1	About debug .....	8-2
	8.2	About the AHB-AP .....	8-6
	8.3	About the Flash Patch and Breakpoint Unit (FPB) .....	8-9
<b>Chapter 9</b>		<b>Data Watchpoint and Trace Unit</b>	
	9.1	About the DWT .....	9-2
	9.2	DWT functional description .....	9-3
	9.3	DWT Programmers Model .....	9-4
<b>Chapter 10</b>		<b>Instrumentation Trace Macrocell Unit</b>	
	10.1	About the ITM .....	10-2
	10.2	ITM functional description .....	10-3
	10.3	ITM programmers model .....	10-4
<b>Chapter 11</b>		<b>Trace Port Interface Unit</b>	
	11.1	About the Cortex-M4 TPIU .....	11-2
	11.2	TPIU functional description .....	11-3
	11.3	TPIU programmers model .....	11-5
<b>Appendix A</b>		<b>Revisions</b>	
		<b>Glossary</b>	

# List of Tables

## Cortex-M4 Technical Reference Manual

	Change History .....	ii
Table 3-1	Cortex-M4 instruction set summary .....	3-4
Table 3-2	Cortex-M4 DSP instruction set summary .....	3-8
Table 3-3	Memory regions .....	3-14
Table 4-1	System control registers .....	4-3
Table 4-2	ACTLR bit assignments .....	4-5
Table 4-3	CPUID bit assignments .....	4-6
Table 4-4	AFSR bit assignments .....	4-7
Table 5-1	MPU registers .....	5-4
Table 6-1	NVIC registers .....	6-4
Table 6-2	ICTR bit assignments .....	6-5
Table 7-1	FPU instruction set .....	7-4
Table 7-2	Default NaN values .....	7-6
Table 7-3	QNaN and SNaN handling .....	7-7
Table 7-4	Cortex-M4F Floating Point system registers .....	7-9
Table 8-1	Cortex-M4 ROM table identification values .....	8-3
Table 8-2	Cortex-M4 ROM table components .....	8-3
Table 8-3	SCS identification values .....	8-4
Table 8-4	Debug registers .....	8-5
Table 8-5	AHB-AP register summary .....	8-6
Table 8-6	CSW bit assignments .....	8-7
Table 8-7	FPB register summary .....	8-10
Table 9-1	DWT register summary .....	9-4
Table 10-1	ITM register summary .....	10-4
Table 10-2	ITM_TPR bit assignments .....	10-5
Table 11-1	TPIU registers .....	11-5
Table 11-2	TPIU_ACPR bit assignments .....	11-6
Table 11-3	TPIU_FFSR bit assignments .....	11-7
Table 11-4	TPIU_FFCR bit assignments .....	11-7
Table 11-5	TRIGGER bit assignments .....	11-8

Table 11-6	Integration ETM Data bit assignments .....	11-9
Table 11-7	ITATBCTR2 bit assignments .....	11-10
Table 11-8	Integration ITM Data bit assignments .....	11-10
Table 11-9	ITATBCTR0 bit assignments .....	11-11
Table 11-10	TPIU_ITCTRL bit assignments .....	11-12
Table 11-11	TPIU_DEVID bit assignments .....	11-12
Table A-1	Issue A .....	A-1
Table A-2	Differences between issue A and issue BC .....	A-1

# List of Figures

## Cortex-M4 Technical Reference Manual

Figure 2-1	Cortex-M4 block diagram .....	2-2
Figure 3-1	System address map .....	3-14
Figure 3-2	Bit-band mapping .....	3-20
Figure 3-3	Processor register set .....	3-21
Figure 4-1	ACTLR bit assignments .....	4-5
Figure 4-2	CPUID bit assignments .....	4-6
Figure 4-3	AFSR bit assignments .....	4-6
Figure 6-1	ICTR bit assignments .....	6-4
Figure 7-1	FPU register bank .....	7-3
Figure 8-1	CoreSight discovery .....	8-2
Figure 8-2	CSW bit assignments .....	8-7
Figure 10-1	ITM_TPR bit assignments .....	10-5
Figure 11-1	TPIU block diagram .....	11-3
Figure 11-2	TPIU_ACPR bit assignments .....	11-6
Figure 11-3	TPIU_FFSR bit assignments .....	11-6
Figure 11-4	TPIU_FFCR bit assignments .....	11-7
Figure 11-5	TRIGGER bit assignments .....	11-8
Figure 11-6	Integration ETM Data bit assignments .....	11-9
Figure 11-7	ITATBCTR2 bit assignments .....	11-9
Figure 11-8	Integration ITM Data bit assignments .....	11-10
Figure 11-9	ITATBCTR0 bit assignments .....	11-11
Figure 11-10	TPIU_ITCTRL bit assignments .....	11-11
Figure 11-11	TPIU_DEVID bit assignments .....	11-12

# Preface

This preface introduces the *Cortex-M4 Technical Reference Manual* (TRM). It contains the following sections:

- *About this book* on page ix
- *Feedback* on page xi.



## About this book

This book is for the Cortex-M4 processor.

## Product revision status

The *rnpn* identifier indicates the revision status of the product described in this manual, where:

- rn** Identifies the major revision of the product.
- pn** Identifies the minor revision or modification status of the product.

## Intended audience

This manual is written to help system designers, system integrators, verification engineers, and software programmers who are implementing a *System-on-Chip* (SoC) device based on the Cortex-M4 processor.

## Using this book

This book is organized into the following chapters:

### Chapter 1 *Introduction*

Read this for a description of the components of the processor, and of the product documentation.

### Chapter 2 *Functional Description*

Read this for a description of the functionality of the processor.

### Chapter 3 *Programmers Model*

Read this for a description of the processor register set, modes of operation, and other information for programming the processor.

### Chapter 4 *System Control*

Read this for a description of the registers and programmers model for system control.

### Chapter 5 *Memory Protection Unit*

Read this for a description of the *Memory Protection Unit* (MPU).

### Chapter 6 *Nested Vectored Interrupt Controller*

Read this for a description of the interrupt processing and control.

### Chapter 7 *Floating Point Unit*

Read this for a description of the *Floating Point Unit* (FPU)

### Chapter 8 *Debug*

Read this for information about debugging and testing the processor core.

### Chapter 9 *Data Watchpoint and Trace Unit*

Read this for a description of the *Data Watchpoint and Trace* (DWT) unit.

### Chapter 10 *Instrumentation Trace Macrocell Unit*

Read this for a description of the *Instrumentation Trace Macrocell* (ITM) unit.

### Chapter 11 *Trace Port Interface Unit*

Read this for a description of the *Trace Port Interface Unit* (TPIU).

**Glossary** Read this for definitions of terms used in this book.

## Conventions

Conventions that this book can use are described in:

- *Typographical*

### Typographical

The typographical conventions are:

<i>italic</i>	Highlights important notes, introduces special terminology, denotes internal cross-references, and citations.
<b>bold</b>	Highlights interface elements, such as menu names. Denotes signal names. Also used for terms in descriptive lists, where appropriate.
monospace	Denotes text that you can enter at the keyboard, such as commands, file and program names, and source code.
<u>monospace</u>	Denotes a permitted abbreviation for a command or option. You can enter the underlined text instead of the full command or option name.
<i>monospace italic</i>	Denotes arguments to monospace text where the argument is to be replaced by a specific value.
<b>monospace</b>	Denotes language keywords when used outside example code.
< <b>and</b> >	Enclose replaceable terms for assembler syntax where they appear in code or code fragments. For example: ADD Rd, Rn, <op2>

## Additional reading

This section lists publications by ARM and by third parties.

See Infocenter, <http://infocenter.arm.com>, for access to ARM documentation.

### ARM publications

This book contains information that is specific to this product. See the following documents for other relevant information:

- *ARMv7-M Architecture Reference Manual* (ARM DDI 0403)
- *ARM Cortex-M4 Integration and Implementation Manual* (ARM DII 0239)
- *ARM ETM-M4 Technical Reference Manual* (ARM DDI 0440)
- *ARM AMBA® 3 AHB-Lite Protocol (v1.0)* (ARM IHI 0033)
- *ARM AMBA™ 3 APB Protocol Specification* (ARM IHI 0024)
- *ARM CoreSight™ Components Technical Reference Manual* (ARM DDI 0314)
- *ARM Debug Interface v5 Architecture Specification* (ARM IHI 0031)
- *ARM Embedded Trace Macrocell Architecture Specification* (ARM IHI 0014).

### Other publications

This section lists relevant documents published by third parties:

- IEEE Standard *Test Access Port and Boundary-Scan Architecture* 1149.1-2001 (JTAG)
- IEEE Standard *IEEE Standard for Binary Floating-Point Arithmetic* 754-2008.

## Feedback

ARM welcomes feedback on this product and its documentation.

### Feedback on this product

If you have any comments or suggestions about this product, contact your supplier and give:

- The product name.
- The product revision or version.
- An explanation with as much information as you can provide. Include symptoms and diagnostic procedures if appropriate.

### Feedback on this manual

If you have comments on content then send e-mail to [errata@arm.com](mailto:errata@arm.com). Give:

- the title
- the number, ARM DDI 0439
- the page number(s) to which your comments refer
- a concise explanation of your comments.

ARM also welcomes general suggestions for additions and improvements.

# Chapter 1

## Introduction

This chapter introduces the processor and instruction set. It contains the following sections:

- *About the processor* on page 1-2
- *Features* on page 1-3
- *Interfaces* on page 1-4
- *Configurable options* on page 1-5
- *Product documentation* on page 1-6

## 1.1 About the processor

The Cortex-M4 processor is a low-power processor that features low gate count, low interrupt latency, and low-cost debug. The Cortex-M4F is a processor with the same capability as the Cortex-M4 processor, and includes floating point arithmetic functionality (see Chapter 7 *Floating Point Unit*). Both processors are intended for deeply embedded applications that require fast interrupt response features.

Throughout this document the name Cortex-M4 refers to both Cortex-M4 and Cortex-M4F processors unless otherwise indicated.

## 1.2 Features

The Cortex-M4 processor incorporates:

- A processor core
- A *Nested Vectored Interrupt Controller* (NVIC) closely integrated with the processor core to achieve low latency interrupt processing
- Multiple high-performance bus interfaces
- A low-cost debug solution with the optional ability to:
  - implement breakpoints and code patches
  - implement watchpoints, tracing, and system profiling
  - support printf style debugging.
  - bridge to a *Trace Port Analyzer* (TPA)
- An optional *Memory Protection Unit* (MPU).
- A Floating Point Unit (FPU) unit, in the Cortex-M4F processor.

## 1.3 Interfaces

The processor has the following external interfaces:

- multiple memory and device bus interfaces
- ETM interface
- trace port interface
- debug port interface.

## 1.4 Configurable options

You can configure your Cortex-M4 implementation to include the following optional components:

- MPU. See Chapter 5 *Memory Protection Unit*.
- FPB. See Chapter 8 *Debug*.
- DWT. See Chapter 9 *Data Watchpoint and Trace Unit*.
- ITM. See Chapter 10 *Instrumentation Trace Macrocell Unit*.
- ETM. See the *ETM-M4 Technical Reference Manual*.
- AHB-AP. See Chapter 8 *Debug*.
- HTM interface. See *AHB Trace Macrocell interface* on page 2-6.
- TPIU. See Chapter 11 *Trace Port Interface Unit*.
- WIC. See *Low power modes* on page 6-3.
- Debug Port. See *Debug port AHB-AP interface* on page 2-6
- FPU. See Chapter 7 *Floating Point Unit*.
- Bit-banding, see *Bit-banding* on page 3-19

———— **Note** —————

You can only configure trace functionality in the following combinations:

- no trace functionality
- ITM and DWT
- ITM, DWT, and ETM
- ITM, DWT, ETM, and HTM.

You can configure the features provided in the DWT independently.

---



## 1.5 Product documentation

This section describes the processor books, how they relate to the design flow, and the relevant architectural standards and protocols.

See *Additional reading* on page x for more information about the books described in this section.

### 1.5.1 Documentation

The Cortex-M4 documentation is as follows:

#### Technical Reference Manual

The *Technical Reference Manual* (TRM) describes the functionality and the effects of functional options on the behavior of the Cortex-M4 processor. It is required at all stages of the design flow. Some behavior described in the TRM might not be relevant because of the way that the Cortex-M4 processor is implemented and integrated. If you are programming the Cortex-M4 processor then contact:

- the implementor to determine:
  - the build configuration of the implementation
  - what integration, if any, was performed before implementing the processor
- the integrator to determine the pin configuration of the SoC that you are using.

#### Integration and Implementation Manual

The *Integration and Implementation Manual* (IIM) describes:

- The available build configuration options and related issues in selecting them.
- How to configure the *Register Transfer Level* (RTL) with the build configuration options
- How to integrate the processor into a SoC. This includes a description of the integration kit and describes the pins that the integrator must tie off to configure the macrocell for the required integration.
- How to implement the processor into your design. This includes floorplanning guidelines, Design for Test (DFT) information, and how to perform netlist dynamic verification on the processor.
- The processes to sign off the integration and implementation of the design.

The ARM product deliverables include reference scripts and information about using them to implement your design.

Reference methodology documentation from your EDA tools vendor complements the IIM.

The IIM is a confidential book that is only available to licensees.

#### ETM-M4 Technical Reference Manual

The ETM-M4 *Technical Reference Manual* (TRM) describes the functionality and behavior of the Cortex-M4 Embedded Trace Macrocell. It is required at all stages of the design flow. Typically the ETM-M4 is integrated with the Cortex-M4 processor prior to implementation as a single macrocell.

## Cortex-M4 User Guide Reference Material

This document provides reference material that ARM partners can configure and include in a User Guide for an ARM Cortex-M4 processor. Typically:

- each chapter in this reference material might correspond to a section in the User Guide
- each top-level section in this reference material might correspond to a chapter in the User Guide.

However, you can organize this material in any way, subject to the conditions of the licence agreement under which ARM supplied the material.

## 1.5.2 Design Flow

The processor is delivered as synthesizable RTL. Before it can be used in a product, it must go through the following process:

### Implementation

The implementor configures and synthesizes the RTL to produce a hard macrocell. This might include integrating RAMs into the design.

**Integration** The integrator connects the implemented design into a SoC. This includes connecting it to a memory system and peripherals.

### Programming

The system programmer develops the software required to configure and initialize the processor, and tests the required application software.

Each stage in the process can be performed by a different party. Implementation and integration choices affect the behavior and features of the processor.

For MCUs, often a single design team integrates the processor before synthesizing the complete design. Alternatively, the team can synthesise the processor on its own or partially integrated, to produce a macrocell that is then integrated, possibly by a separate team.

The operation of the final device depends on:

### Build configuration

The implementor chooses the options that affect how the RTL source files are pre-processed. These options usually include or exclude logic that affects one or more of the area, maximum frequency, and features of the resulting macrocell.

### Configuration inputs

The integrator configures some features of the processor by tying inputs to specific values. These configurations affect the start-up behavior before any software configuration is made. They can also limit the options available to the software.

### Software configuration

The programmer configures the processor by programming particular values into registers. This affects the behavior of the processor.

---

**Note**

---

This manual refers to implementation-defined features that are applicable to build configuration options. Reference to a feature that is included means that the appropriate build and pin configuration options are selected. Reference to an enabled feature means one that has also been configured by software.

---

**1.5.3 Architecture and protocol information**

The processor complies with, or implements, the specifications described in:

- *ARM architecture*
- *Bus architecture*
- *Debug*
- *Embedded Trace Macrocell.*

This book complements architecture reference manuals, architecture specifications, protocol specifications, and relevant external standards. It does not duplicate information from these sources.

**ARM architecture**

The processor implements the ARMv7-M architecture profile. See the *ARMv7-M Architecture Reference Manual*.

**Bus architecture**

The processor provides three primary bus interfaces implementing a variant of the AMBA 3 AHB-Lite protocol. The processor implements an interface for CoreSight and other debug components using the AMBA 3 APB protocol. See

- the *ARM AMBA 3 AHB-Lite Protocol (v1.0)*
- the *ARM AMBA 3 APB Protocol Specification*.

**Debug**

The debug features of the processor implement the ARM debug interface architecture. See the *ARM Debug Interface v5 Architecture Specification*.

**Embedded Trace Macrocell**

The trace features of the processor implement the ARM Embedded Trace Macrocell architecture. See the *ARM Embedded Trace Macrocell Architecture Specification*.

**Floating Point Unit**

The Cortex-M4F processor implements single precision floating-point data processing as defined by the FPv4-SP architecture, that is part of the ARMv7-M architecture. It provides floating-point computation functionality that is compliant with the *ANSI/IEEE Std 754-2008, IEEE Standard for Binary Floating-Point Arithmetic*. See the *ARMv7M Architecture Reference Manual* and Chapter 7 *Floating Point Unit*.

# Chapter 2

## Functional Description

This chapter introduces the processor and its external interfaces. It contains the following sections:

- *About the functions* on page 2-2
- *Interfaces* on page 2-5.

## 2.1 About the functions

Figure 2-1 shows the structure of the Cortex-M4 processor.

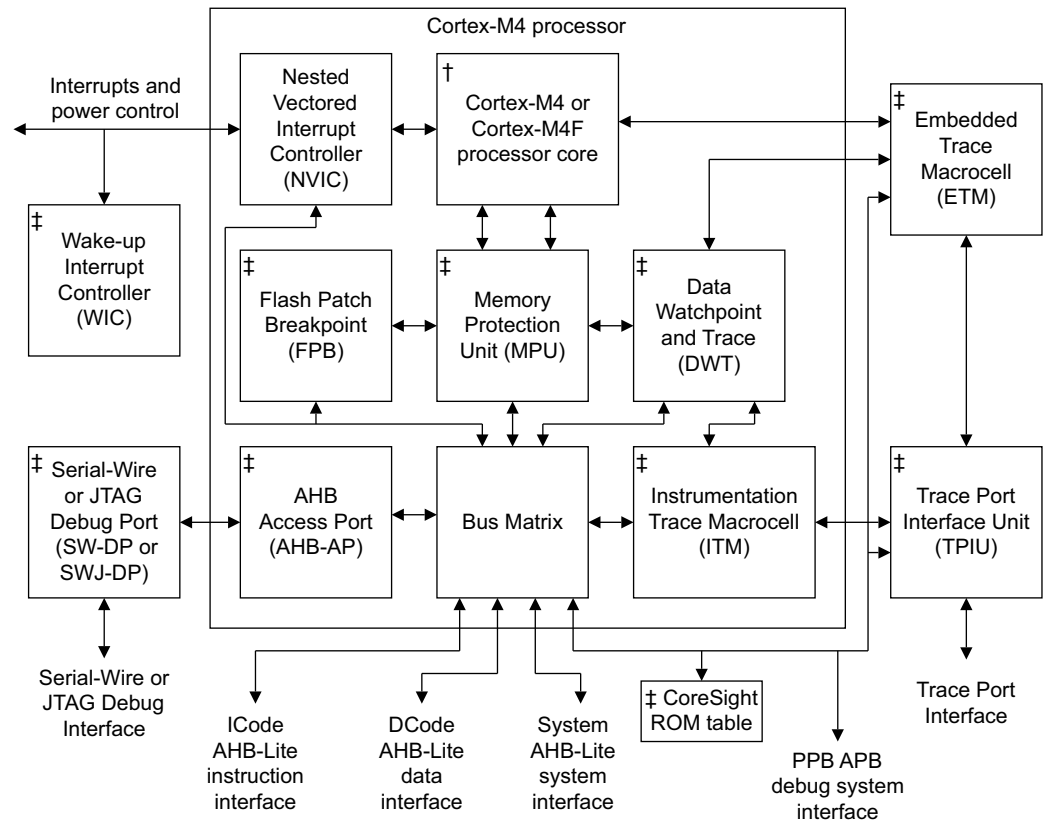

† For the Cortex-M4F processor, the core includes a Floating Point Unit (FPU)

‡ Optional component

**Figure 2-1 Cortex-M4 block diagram**

The Cortex-M4 processor features:

- A low gate count processor core, with low latency interrupt processing that has:
  - A subset of the Thumb instruction set, defined in the *ARMv7-M Architecture Reference Manual*.
  - Banked *Stack Pointer* (SP).
  - Hardware divide instructions, SDIV and UDIV.
  - Handler and Thread modes.
  - Thumb and Debug states.
  - Support for interruptible-continued instructions LDM, STM, PUSH, and POP for low interrupt latency.
  - Automatic processor state saving and restoration for low latency *Interrupt Service Routine* (ISR) entry and exit.
  - Support for ARMv6 big-endian byte-invariant or little-endian accesses.
  - Support for ARMv6 unaligned accesses.

- *Floating Point Unit* (FPU) in the Cortex-M4F processor providing:
  - 32-bit instructions for single-precision (C float) data-processing operations.
  - Combined Multiply and Accumulate instructions for increased precision (Fused MAC).
  - Hardware support for conversion, addition, subtraction, multiplication with optional accumulate, division, and square-root.
  - Hardware support for denormals and all IEEE rounding modes.
  - 32 dedicated 32-bit single precision registers, also addressable as 16 double-word registers.
  - Decoupled three stage pipeline.
- *Nested Vectored Interrupt Controller* (NVIC) closely integrated with the processor core to achieve low latency interrupt processing. Features include:
  - External interrupts, configurable from 1 to 240.
  - Bits of priority, configurable from 3 to 8.
  - Dynamic reprioritization of interrupts.
  - Priority grouping. This enables selection of preempting interrupt levels and non preempting interrupt levels.
  - Support for tail-chaining and late arrival of interrupts. This enables back-to-back interrupt processing without the overhead of state saving and restoration between interrupts.
  - Processor state automatically saved on interrupt entry, and restored on interrupt exit, with no instruction overhead.
  - Optional *Wake-up Interrupt Controller* (WIC), providing ultra-low power sleep mode support.
- *Memory Protection Unit* (MPU). An optional MPU for memory protection, including:
  - Eight memory regions.
  - *Sub Region Disable* (SRD), enabling efficient use of memory regions.
  - The ability to enable a background region that implements the default memory map attributes.
- Bus interfaces:
  - Three *Advanced High-performance Bus-Lite* (AHB-Lite) interfaces: ICode, DCode, and System bus interfaces.
  - *Private Peripheral Bus* (PPB) based on *Advanced Peripheral Bus* (APB) interface.
  - Bit-band support that includes atomic bit-band write and read operations.
  - Memory access alignment.
  - Write buffer for buffering of write data.
  - Exclusive access transfers for multiprocessor systems.
- Low-cost debug solution that features:
  - Debug access to all memory and registers in the system, including access to memory mapped devices, access to internal core registers when the core is halted, and access to debug control registers even while **SYSRESETn** is asserted.
  - *Serial Wire Debug Port* (SW-DP) or *Serial Wire JTAG Debug Port* (SWJ-DP) debug access, or both.

- Optional *Flash Patch and Breakpoint* (FPB) unit for implementing breakpoints and code patches.
- Optional *Data Watchpoint and Trace* (DWT) unit for implementing watchpoints, data tracing, and system profiling.
- Optional *Instrumentation Trace Macrocell* (ITM) for support of printf style debugging.
- Optional *Trace Port Interface Unit* (TPIU) for bridging to a *Trace Port Analyzer* (TPA), including *Single Wire Output* (SWO) mode.
- Optional *Embedded Trace Macrocell* (ETM) for instruction trace.

## 2.2 Interfaces

The processor contains the following external interfaces:

- bus interfaces
- *ETM interface* on page 2-6
- *AHB Trace Macrocell interface* on page 2-6
- *Debug port AHB-AP interface* on page 2-6.

### 2.2.1 Bus interfaces

The processor contains four external *Advanced High-performance Bus* (AHB)-Lite bus interfaces:

#### ICode memory interface

Instruction fetches from Code memory space,  $0x00000000$  to  $0x1FFFFFFF$ , are performed over this 32-bit AHB-Lite bus.

The Debugger cannot access this interface. All fetches are word-wide. The number of instructions fetched per word depends on the code running and the alignment of the code in memory.

#### DCode memory interface

Data and debug accesses to Code memory space,  $0x00000000$  to  $0x1FFFFFFF$ , are performed over this 32-bit AHB-Lite bus. Core data accesses have a higher priority than debug accesses on this bus. This means that debug accesses are waited until core accesses have completed when there are simultaneous core and debug access to this bus.

Control logic in this interface converts unaligned data and debug accesses into two or three aligned accesses, depending on the size and alignment of the unaligned access. This stalls any subsequent data or debug access until the unaligned access has completed.

———— **Note** —————

ARM strongly recommends that any external arbitration between the ICode and DCode AHB bus interfaces ensures that DCode has a higher priority than ICode.

#### System interface

Instruction fetches, and data and debug accesses, to address ranges  $0x20000000$  to  $0xDFFFFFFF$  and  $0xE0100000$  to  $0xFFFFFFFF$  are performed over this 32-bit AHB-Lite bus.

For simultaneous accesses to this bus, the arbitration order in decreasing priority is:

- data accesses
- instruction and vector fetches
- debug.

The system bus interface contains control logic to handle unaligned accesses, FPB remapped accesses, bit-band accesses, and pipelined instruction fetches.

#### Private Peripheral Bus (PPB)

Data and debug accesses to external PPB space,  $0xE0040000$  to  $0xE00FFFFF$ , are performed over this 32-bit *Advanced Peripheral Bus* (APB) bus. The *Trace Port Interface Unit* (TPIU) and vendor specific peripherals are on this bus.



Core data accesses have higher priority than debug accesses, so debug accesses are waited until core accesses have completed when there are simultaneous core and debug access to this bus. Only the address bits necessary to decode the External PPB space are supported on this interface.

### 2.2.2 ETM interface

The ETM interface enables simple connection of an ETM to the processor. It provides a channel for instruction trace to the ETM. See the *ARM Embedded Trace Macrocell Architecture Specification*.

### 2.2.3 AHB Trace Macrocell interface

The *AHB Trace Macrocell* (HTM) interface enables a simple connection of the AHB trace macrocell to the processor. It provides a channel for the data trace to the HTM.

Your implementation must include this interface to use the HTM interface. You must set TRCENA to 1 in the Debug Exception and Monitor Control Register (DEMCR) before you enable the HTM to enable the HTM port to supply trace data. See the *ARMv7-M Architecture Reference Manual*.

### 2.2.4 Debug port AHB-AP interface

The processor contains an *Advanced High-performance Bus Access Port* (AHB-AP) interface for debug accesses. An external *Debug Port* (DP) component accesses this interface. The Cortex-M4 system supports three possible DP implementations:

- The *Serial Wire JTAG Debug Port* (SWJ-DP). The SWJ-DP is a standard CoreSight debug port that combines JTAG-DP and *Serial Wire Debug Port* (SW-DP).
- The SW-DP. This provides a two-pin interface to the AHB-AP port.
- No DP present. If no debug functionality is present within the processor, a DP is not required.

The two DP implementations provide different mechanisms for debug access to the processor. Your implementation must contain only one of these components.

———— **Note** —————

Your implementation might contain an alternative implementer-specific DP instead of SW-DP or SWJ-DP. See your implementer for details.

For more detailed information on the DP components, see the *CoreSight Components Technical Reference manual*.

For more information on the AHB-AP, see Chapter 8 *Debug*.

The DP and AP together are referred to as the *Debug Access Port* (DAP).

For more detailed information on the debug interface, see the *ARM Debug Interface v5 Architecture Specification*.

# Chapter 3

## Programmers Model

This chapter describes the processor programmers model. It contains the following sections:

- *About the programmers model* on page 3-2
- *Modes of operation and execution* on page 3-3
- *Instruction set summary* on page 3-4.
- *System address map* on page 3-14
- *Write buffer* on page 3-17
- *Bit-banding* on page 3-19
- *Processor core register summary* on page 3-21
- *Exceptions* on page 3-23.

### 3.1 About the programmers model

The *ARMv7-M Architecture Reference Manual* provides a complete description of the programmers model. This chapter gives an overview of the Cortex-M4 processor programmers model that describes the implementation-defined options. It also contains the ARMv7-M Thumb instructions it uses and their cycle counts for the processor. In addition:

- Chapter 4 summarizes the system control features of the programmers model
- Chapter 5 summarizes the MPU features of the programmers model
- Chapter 6 summarizes the NVIC features of the programmers model
- Chapter 7 summarizes the FPU features of the programmers model
- Chapter 8 summarizes the Debug features of the programmers model.
- Chapter 9 summarizes the DWT features of the programmers model
- Chapter 10 summarizes the ITM features of the programmers model
- Chapter 11 summarizes the TPIU features of the programmers model.

## 3.2 Modes of operation and execution

This section briefly describes the modes of operation and execution of the Cortex-M4 processor. See the *ARMv7-M Architecture Reference Manual* for more information.

### 3.2.1 Operating modes

The processor supports two modes of operation, Thread mode and Handler mode:

- The processor enters Thread mode on Reset, or as a result of an exception return. Privileged and Unprivileged code can run in Thread mode.
- The processor enters Handler mode as a result of an exception. All code is privileged in Handler mode.

### 3.2.2 Operating states

The processor can operate in one of two operating states:

- Thumb state. This is normal execution running 16-bit and 32-bit halfword aligned Thumb instructions.
- Debug State. This is the state when the processor is in halting debug.

### 3.2.3 Privileged access and user access

Code can execute as privileged or unprivileged. Unprivileged execution limits or excludes access to some resources. Privileged execution has access to all resources. Handler mode is always privileged. Thread mode can be privileged or unprivileged.

### 3.3 Instruction set summary

This section provides information on:

- *Cortex-M4 instructions*
- *Load/store timings* on page 3-11
- *Binary compatibility with other Cortex processors* on page 3-12.

#### 3.3.1 Cortex-M4 instructions

The processor implements the ARMv7-M Thumb instruction set. Table 3-1 shows the Cortex-M4 instructions and their cycle counts. The cycle counts are based on a system with zero wait states.

Within the assembler syntax, depending on the operation, the <op2> field can be replaced with one of the following options:

- a simple register specifier, for example Rm
- an immediate shifted register, for example Rm, LSL #4
- a register shifted register, for example Rm, LSL Rs
- an immediate value, for example #0xE000E000.

For brevity, not all load and store addressing modes are shown. See the *ARMv7-M Architecture Reference Manual* for more information.

Table 3-1 uses the following abbreviations in the Cycles column:

- P** The number of cycles required for a pipeline refill. This ranges from 1 to 3 depending on the alignment and width of the target instruction, and whether the processor manages to speculate the address early.
- B** The number of cycles required to perform the barrier operation. For DSB and DMB, the minimum number of cycles is zero. For ISB, the minimum number of cycles is equivalent to the number required for a pipeline refill.
- N** The number of registers in the register list to be loaded or stored, including PC or LR.
- W** The number of cycles spent waiting for an appropriate event.

**Table 3-1 Cortex-M4 instruction set summary**

Operation	Description	Assembler	Cycles
Move	Register	MOV Rd, <op2>	1
	16-bit immediate	MOVW Rd, #<imm>	1
	Immediate into top	MOVT Rd, #<imm>	1
	To PC	MOV PC, Rm	1 + P
Add	Add	ADD Rd, Rn, <op2>	1
	Add to PC	ADD PC, PC, Rm	1 + P
	Add with carry	ADC Rd, Rn, <op2>	1
	Form address	ADR Rd, <label>	1

**Table 3-1 Cortex-M4 instruction set summary (continued)**

Operation	Description	Assembler	Cycles
Subtract	Subtract	SUB Rd, Rn, <op2>	1
	Subtract with borrow	SBC Rd, Rn, <op2>	1
	Reverse	RSB Rd, Rn, <op2>	1
Multiply	Multiply	MUL Rd, Rn, Rm	1
	Multiply accumulate	MLA Rd, Rn, Rm	2
	Multiply subtract	MLS Rd, Rn, Rm	2
	Long signed	SMULL RdLo, RdHi, Rn, Rm	1
	Long unsigned	UMULL RdLo, RdHi, Rn, Rm	1
	Long signed accumulate	SMLAL RdLo, RdHi, Rn, Rm	1
	Long unsigned accumulate	UMLAL RdLo, RdHi, Rn, Rm	1
Divide	Signed	SDIV Rd, Rn, Rm	2 to 12 <sup>a</sup>
	Unsigned	UDIV Rd, Rn, Rm	2 to 12 <sup>a</sup>
Saturate	Signed	SSAT Rd, #<imm>, <op2>	1
	Unsigned	USAT Rd, #<imm>, <op2>	1
Compare	Compare	CMP Rn, <op2>	1
	Negative	CMN Rn, <op2>	1
Logical	AND	AND Rd, Rn, <op2>	1
	Exclusive OR	EOR Rd, Rn, <op2>	1
	OR	ORR Rd, Rn, <op2>	1
	OR NOT	ORN Rd, Rn, <op2>	1
	Bit clear	BIC Rd, Rn, <op2>	1
	Move NOT	MVN Rd, <op2>	1
	AND test	TST Rn, <op2>	1
	Exclusive OR test	TEQ Rn, <op1>	1
Shift	Logical shift left	LSL Rd, Rn, #<imm>	1
	Logical shift left	LSL Rd, Rn, Rs	1
	Logical shift right	LSR Rd, Rn, #<imm>	1
	Logical shift right	LSR Rd, Rn, Rs	1
	Arithmetic shift right	ASR Rd, Rn, #<imm>	1
	Arithmetic shift right	ASR Rd, Rn, Rs	1
Rotate	Rotate right	ROR Rd, Rn, #<imm>	1
	Rotate right	ROR Rd, Rn, Rs	1
	With extension	RRX Rd, Rn	1

**Table 3-1 Cortex-M4 instruction set summary (continued)**

Operation	Description	Assembler	Cycles
Count	Leading zeroes	CLZ Rd, Rn	1
Load	Word	LDR Rd, [Rn, <op2>]	2 <sup>b</sup>
	To PC	LDR PC, [Rn, <op2>]	2 <sup>b</sup> + P
	Halfword	LDRH Rd, [Rn, <op2>]	2 <sup>b</sup>
	Byte	LDRB Rd, [Rn, <op2>]	2 <sup>b</sup>
	Signed halfword	LDRSH Rd, [Rn, <op2>]	2 <sup>b</sup>
	Signed byte	LDRSB Rd, [Rn, <op2>]	2 <sup>b</sup>
	User word	LDRT Rd, [Rn, #<imm>]	2 <sup>b</sup>
	User halfword	LDRHT Rd, [Rn, #<imm>]	2 <sup>b</sup>
	User byte	LDRBT Rd, [Rn, #<imm>]	2 <sup>b</sup>
	User signed halfword	LDRSHT Rd, [Rn, #<imm>]	2 <sup>b</sup>
	User signed byte	LDRSBT Rd, [Rn, #<imm>]	2 <sup>b</sup>
	PC relative	LDR Rd, [PC, #<imm>]	2 <sup>b</sup>
	Doubleword	LDRD Rd, Rd, [Rn, #<imm>]	1 + N
	Multiple	LDM Rn, {<reglist>}	1 + N
	Multiple including PC	LDM Rn, {<reglist>, PC}	1 + N + P
Store	Word	STR Rd, [Rn, <op2>]	2 <sup>b</sup>
	Halfword	STRH Rd, [Rn, <op2>]	2 <sup>b</sup>
	Byte	STRB Rd, [Rn, <op2>]	2 <sup>b</sup>
	Signed halfword	STRSH Rd, [Rn, <op2>]	2 <sup>b</sup>
	Signed byte	STRSB Rd, [Rn, <op2>]	2 <sup>b</sup>
	User word	STRT Rd, [Rn, #<imm>]	2 <sup>b</sup>
	User halfword	STRHT Rd, [Rn, #<imm>]	2 <sup>b</sup>
	User byte	STRBT Rd, [Rn, #<imm>]	2 <sup>b</sup>
	User signed halfword	STRSHT Rd, [Rn, #<imm>]	2 <sup>b</sup>
	User signed byte	STRSBT Rd, [Rn, #<imm>]	2 <sup>b</sup>
	Doubleword	STRD Rd, Rd, [Rn, #<imm>]	1 + N
	Multiple	STM Rn, {<reglist>}	1 + N
	Push	Push	PUSH {<reglist>}
Push with link register		PUSH {<reglist>, LR}	1 + N
Pop	Pop	POP {<reglist>}	1 + N
	Pop and return	POP {<reglist>, PC}	1 + N + P

**Table 3-1 Cortex-M4 instruction set summary (continued)**

Operation	Description	Assembler	Cycles
Semaphore	Load exclusive	LDREX Rd, [Rn, #<imm>]	2
	Load exclusive half	LDREXH Rd, [Rn]	2
	Load exclusive byte	LDREXB Rd, [Rn]	2
	Store exclusive	STREX Rd, Rt, [Rn, #<imm>]	2
	Store exclusive half	STREXH Rd, Rt, [Rn]	2
	Store exclusive byte	STREXB Rd, Rt, [Rn]	2
	Clear exclusive monitor	CLREX	1
Branch	Conditional	B<cc> <label>	1 or 1 + P <sup>c</sup>
	Unconditional	B <label>	1 + P
	With link	BL <label>	1 + P
	With exchange	BX Rm	1 + P
	With link and exchange	BLX Rm	1 + P
	Branch if zero	CBZ Rn, <label>	1 or 1 + P <sup>c</sup>
	Branch if non-zero	CBNZ Rn, <label>	1 or 1 + P <sup>c</sup>
	Byte table branch	TBB [Rn, Rm]	2 + P
	Halfword table branch	TBH [Rn, Rm, LSL#1]	2 + P
State change	Supervisor call	SVC #<imm>	-
	If-then-else	IT... <cond>	1 <sup>d</sup>
	Disable interrupts	CPSID <flags>	1 or 2
	Enable interrupts	CPSIE <flags>	1 or 2
	Read special register	MRS Rd, <specreg>	1 or 2
	Write special register	MSR <specreg>, Rn	1 or 2
	Breakpoint	BKPT #<imm>	-
Extend	Signed halfword to word	SXTH Rd, <op2>	1
	Signed byte to word	SXTB Rd, <op2>	1
	Unsigned halfword	UXTH Rd, <op2>	1
	Unsigned byte	UXTB Rd, <op2>	1
Bit field	Extract unsigned	UBFX Rd, Rn, #<imm>, #<imm>	1
	Extract signed	SBFX Rd, Rn, #<imm>, #<imm>	1
	Clear	BFC Rd, Rn, #<imm>, #<imm>	1
	Insert	BFI Rd, Rn, #<imm>, #<imm>	1



**Table 3-1 Cortex-M4 instruction set summary (continued)**

Operation	Description	Assembler	Cycles
Reverse	Bytes in word	REV Rd, Rm	1
	Bytes in both halfwords	REV16 Rd, Rm	1
	Signed bottom halfword	REVSH Rd, Rm	1
	Bits in word	RBIT Rd, Rm	1
Hint	Send event	SEV	1
	Wait for event	WFE	1 + W
	Wait for interrupt	WFI	1 + W
	No operation	NOP	1
Barriers	Instruction synchronization	ISB	1 + B
	Data memory	DMB	1 + B
	Data synchronization	DSB <flags>	1 + B

- a. Division operations use early termination to minimize the number of cycles required based on the number of leading ones and zeroes in the input operands.
- b. Neighboring load and store single instructions can pipeline their address and data phases. This enables these instructions to complete in a single execution cycle.
- c. Conditional branch completes in a single cycle if the branch is not taken.
- d. An IT instruction can be folded onto a preceding 16-bit Thumb instruction, enabling execution in zero cycles.

Table 3-2 shows the DSP instructions that the Cortex-M4 processor implements.

**Table 3-2 Cortex-M4 DSP instruction set summary**

Operation	Description	Assembler	Cycles
Multiply	32-bit multiply with 32-most-significant-bit accumulate	SMMLA	1
	32-bit multiply with 32-most-significant-bit subtract	SMMLS	1
	32-bit multiply returning 32-most-significant-bits	SMMUL	1
	32-bit multiply with rounded 32-most-significant-bit accumulate	SMMLAR	1
	32-bit multiply with rounded 32-most-significant-bit subtract	SMMLSR	1
	32-bit multiply returning rounded 32-most-significant-bits	SMMULR	1

**Table 3-2 Cortex-M4 DSP instruction set summary (continued)**

Operation	Description	Assembler	Cycles
Signed Multiply	Q setting 16-bit signed multiply with 32-bit accumulate, bottom by bottom	SMLABB	1
	Q setting 16-bit signed multiply with 32-bit accumulate, bottom by top	SMLABT	1
	16-bit signed multiply with 64-bit accumulate, bottom by bottom	SMLALBB	1
	16-bit signed multiply with 64-bit accumulate, bottom by top	SMLALBT	1
	Dual 16-bit signed multiply with single 64-bit accumulator	SMLALD	1
	16-bit signed multiply with 64-bit accumulate, top by bottom	SMLALTB	1
	16-bit signed multiply with 64-bit accumulate, top by top	SMLALTT	1
	16-bit signed multiply yielding 32-bit result, bottom by bottom	SMULBB	1
	16-bit signed multiply yielding 32-bit result, bottom by top	SMULBT	1
	16-bit signed multiply yielding 32-bit result, top by bottom	SMULTB	1
	16-bit signed multiply yielding 32-bit result, top by bottom	SMULTT	1
	16-bit by 32-bit signed multiply returning 32-most-significant-bits, bottom	SMULWB	1
	16-bit by 32-bit signed multiply returning 32-most-significant-bits, top	SMULWT	1
	Dual 16-bit signed multiply returning difference	SMUSD	1
	Q setting 16-bit signed multiply with 32-bit accumulate, top by bottom	SMLATB	1
	Q setting 16-bit signed multiply with 32-bit accumulate, top by top	SMLATT	1
	Q setting dual 16-bit signed multiply with single 32-bit accumulator	SMLAD	1
	Q setting 16-bit by 32-bit signed multiply with 32-bit accumulate, bottom	SMLAWB	1
	Q setting 16-bit by 32-bit signed multiply with 32-bit accumulate, top	SMLAWT	1
	Q setting dual 16-bit signed multiply subtract with 32-bit accumulate	SMLSD	1
Q setting dual 16-bit signed multiply subtract with 64-bit accumulate	SMLS�D	1	
Q setting sum of dual 16-bit signed multiply	SMUAD	1	
Q setting pre-exchanged dual 16-bit signed multiply with single 32-bit accumulator	SMLADX	1	
Unsigned Multiply	32-bit unsigned multiply with double 32-bit accumulation yielding 64-bit result	UMAAL	1
Saturate	Q setting dual 16-bit saturate	SSAT16	1
	Q setting dual 16-bit unsigned saturate	USAT16	1

**Table 3-2 Cortex-M4 DSP instruction set summary (continued)**

<b>Operation</b>	<b>Description</b>	<b>Assembler</b>	<b>Cycles</b>
Packing and Unpacking	Pack half word top with shifted bottom	PKHTB	1
	Pack half word bottom with shifted top	PKHBT	1
	Extract 8-bits and sign extend to 32-bits	SXTB	1
	Dual extract 8-bits and sign extend each to 16-bits	SXTB16	1
	Extract 16-bits and sign extend to 32-bits	SXTH	1
	Extract 8-bits and zero-extend to 32-bits	UXTB	1
	Dual extract 8-bits and zero-extend to 16-bits	UXTB16	1
	Extract 16-bits and zero-extend to 32-bits	UXTH	1
	Extract 8-bit to 32-bit unsigned addition	UXTAB	1
	Dual extracted 8-bit to 16-bit unsigned addition	UXTAB16	1
	Extracted 16-bit to 32-bit unsigned addition	UXTAH	1
	Extracted 8-bit to 32-bit signed addition	SXTAB	1
	Dual extracted 8-bit to 16-bit signed addition	SXTAB16	1
	Extracted 16-bit to 32-bit signed addition	SXTAH	1
Miscellaneous Data Processing	Select bytes based on GE bits	SEL	1
	Unsigned sum of quad 8-bit unsigned absolute difference	USAD8	1
	Unsigned sum of quad 8-bit unsigned absolute difference with 32-bit accumulate	USADA8	1
Addition	Dual 16-bit unsigned saturating addition	UQADD16	1
	Quad 8-bit unsigned saturating addition	UQADD8	1
	Q setting saturating add	QADD	1
	Q setting dual 16-bit saturating add	QADD16	1
	Q setting quad 8-bit saturating add	QADD8	1
	Q setting saturating double and add	QDADD	1
	GE setting quad 8-bit signed addition	SADD8	1
	GE setting dual 16-bit signed addition	SADD16	1
	Dual 16-bit signed addition with halved results	SHADD16	1
	Quad 8-bit signed addition with halved results	SHADD8	1
	GE setting dual 16-bit unsigned addition	UADD16	1
	GE setting quad 8-bit unsigned addition	UADD8	1
	Dual 16-bit unsigned addition with halved results	UHADD16	1
	Quad 8-bit unsigned addition with halved results	UHADD8	1

**Table 3-2 Cortex-M4 DSP instruction set summary (continued)**

Operation	Description	Assembler	Cycles
Subtraction	Q setting saturating double and subtract	QDSUB	1
	Dual 16-bit unsigned saturating subtraction	UQSUB16	1
	Quad 8-bit unsigned saturating subtraction	UQSUB8	1
	Q setting saturating subtract	QSUB	1
	Q setting dual 16-bit saturating subtract	QSUB16	1
	Q setting quad 8-bit saturating subtract	QSUB8	1
	Dual 16-bit signed subtraction with halved results	SHSUB16	1
	Quad 8-bit signed subtraction with halved results	SHSUB8	1
	GE setting dual 16-bit signed subtraction	SSUB16	1
	GE setting quad 8-bit signed subtraction	SSUB8	1
	Dual 16-bit unsigned subtraction with halved results	UHSUB16	1
	Quad 8-bit unsigned subtraction with halved results	UHSUB8	1
	GE setting dual 16-bit unsigned subtract	USUB16	1
	GE setting quad 8-bit unsigned subtract	USUB8	1
Parallel Addition and Subtraction	Dual 16-bit unsigned saturating addition and subtraction with exchange	UQASX	1
	Dual 16-bit unsigned saturating subtraction and addition with exchange	UQSAX	1
	GE setting dual 16-bit addition and subtraction with exchange	SASX	1
	Q setting dual 16-bit add and subtract with exchange	QASX	1
	Q setting dual 16-bit subtract and add with exchange	QSAX	1
	Dual 16-bit signed addition and subtraction with halved results	SHASX	1
	Dual 16-bit signed subtraction and addition with halved results	SHSAX	1
	GE setting dual 16-bit signed subtraction and addition with exchange	SSAX	1
	GE setting dual 16-bit unsigned addition and subtraction with exchange	UASX	1
	Dual 16-bit unsigned addition and subtraction with halved results and exchange	UHASX	1
	Dual 16-bit unsigned subtraction and addition with halved results and exchange	UHSAX	1
GE setting dual 16-bit unsigned subtract and add with exchange	USAX	1	

### 3.3.2 Load/store timings

This section describes how best to pair instructions to achieve more reductions in timing.

- STR Rx, [Ry, #imm] is always one cycle. This is because the address generation is performed in the initial cycle, and the data store is performed at the same time as the next instruction is executing. If the store is to the store buffer, and the store buffer is full or not enabled, the next instruction is delayed until the store can complete. If the store is not to the store buffer, for example to the Code segment, and that transaction stalls, the impact on timing is only felt if another load or store operation is executed before completion.

- LDR PC, [any] is always a blocking operation. This means at least two cycles for the load, and three cycles for the pipeline reload. So this operation takes at least five cycles, or more if stalled on the load or the fetch.
- LDR Rx, [PC, #imm] might add a cycle because of contention with the fetch unit.
- TBB and TBH are also blocking operations. These are at least two cycles for the load, one cycle for the add, and three cycles for the pipeline reload. This means at least six cycles, or more if stalled on the load or the fetch.
- LDR [any] are pipelined when possible. This means that if the next instruction is an LDR or STR, and the destination of the first LDR is not used to compute the address for the next instruction, then one cycle is removed from the cost of the next instruction. So, an LDR might be followed by an STR, so that the STR writes out what the LDR loaded. More multiple LDRs can be pipelined together. Some optimized examples are:
  - LDR R0, [R1]; LDR R1, [R2] - normally three cycles total
  - LDR R0, [R1, R2]; STR R0, [R3, #20] - normally three cycles total
  - LDR R0, [R1, R2]; STR R1, [R3, R2] - normally three cycles total
  - LDR R0, [R1, R5]; LDR R1, [R2]; LDR R2, [R3, #4] - normally four cycles total.
- Other instructions cannot be pipelined after STR with register offset. STR can only be pipelined when it follows an LDR, but nothing can be pipelined after the store. Even a stalled STR normally only takes two cycles, because of the store buffer.
- LDREX and STREX can be pipelined exactly as LDR. Because STREX is treated more like an LDR, it can be pipelined as explained for LDR. Equally LDREX is treated exactly as an LDR and so can be pipelined.
- LDRD and STRD cannot be pipelined with preceding or following instructions. However, the two words are pipelined together. So, this operation requires three cycles when not stalled.
- LDM and STM cannot be pipelined with preceding or following instructions. However, all elements after the first are pipelined together. So, a three element LDM takes 2+1+1 or 5 cycles when not stalled. Similarly, an eight element store takes nine cycles when not stalled. When interrupted, LDM and STM instructions continue from where they left off when returned to. The continue operation adds one or two cycles to the first element when started.
- Unaligned word or halfword loads or stores add penalty cycles. A byte aligned halfword load or store adds one extra cycle to perform the operation as two bytes. A halfword aligned word load or store adds one extra cycle to perform the operation as two halfwords. A byte-aligned word load or store adds two extra cycles to perform the operation as a byte, a halfword, and a byte. These numbers increase if the memory stalls. A STR or STRH cannot delay the processor because of the store buffer.

### 3.3.3 Binary compatibility with other Cortex processors

The processor implements a binary compatible subset of the instruction set and features provided by other Cortex-M profile processors. You can move software, including system level software, from the Cortex-M4 processor to other Cortex-M profile processors.

To ensure a smooth transition, ARM recommends that code designed to operate on other Cortex-M profile processor architectures obey the following rules and configure the *Configuration Control Register* (CCR) appropriately:

- use word transfers only to access registers in the NVIC and *System Control Space* (SCS).
- treat all unused SCS registers and register fields on the processor as Do-Not-Modify.

- configure the following fields in the CCR:
  - STKALIGN bit to 1
  - UNALIGN\_TRP bit to 1
  - Leave all other bits in the CCR register as their original value.

### 3.4 System address map

The processor contains a bus matrix that arbitrates the processor core and optional *Debug Access Port (DAP)* memory accesses to both the external memory system and to the internal *System Control Space (SCS)* and debug components.

Priority is always given to the processor to ensure that any debug accesses are as non-intrusive as possible. For a zero wait state system, all debug accesses to system memory, SCS, and debug resources are completely non-intrusive.

Figure 3-1 shows the system address map.

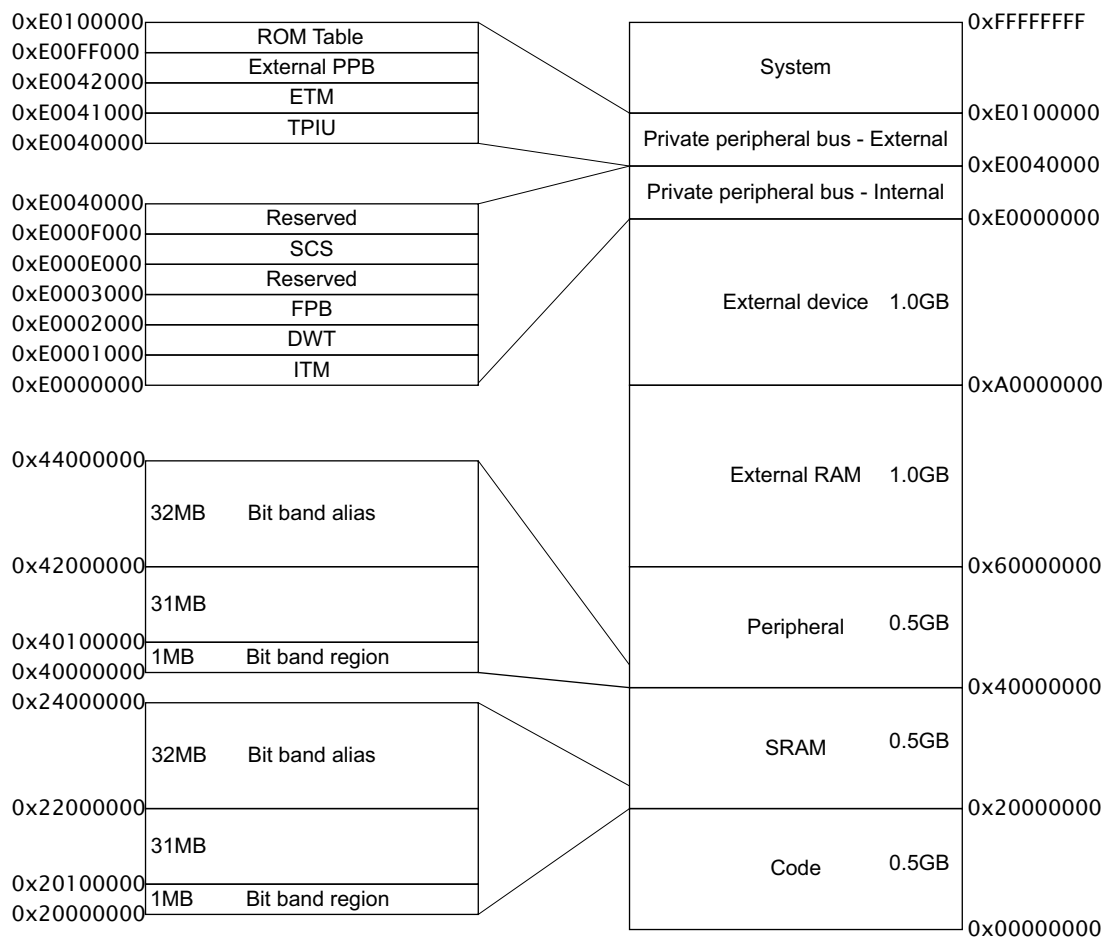

Figure 3-1 System address map

Table 3-3 shows the processor interfaces that are addressed by the different memory map regions.

Table 3-3 Memory regions

Memory Map	Region
Code	Instruction fetches are performed over the ICode bus. Data accesses are performed over the DCode bus.
SRAM	Instruction fetches and data accesses are performed over the system bus.
SRAM bit-band	Alias region. Data accesses are aliases. Instruction accesses are not aliases.

**Table 3-3 Memory regions (continued)**

Memory Map	Region
Peripheral	Instruction fetches and data accesses are performed over the system bus.
Peripheral bit-band	Alias region. Data accesses are aliases. Instruction accesses are not aliases.
External RAM	Instruction fetches and data accesses are performed over the system bus.
External Device	Instruction fetches and data accesses are performed over the system bus.
Private Peripheral Bus	External and internal <i>Private Peripheral Bus</i> (PPB) interfaces. See <i>Private peripheral bus</i> . This memory region is <i>Execute Never</i> (XN), and so instruction fetches are prohibited. An MPU, if present, cannot change this.
System	System segment for vendor system peripherals. This memory region is XN, and so instruction fetches are prohibited. An MPU, if present, cannot change this.

See the *ARMv7-M Architecture Reference Manual* for more information about the memory model.

### 3.4.1 Private peripheral bus

The internal *Private Peripheral Bus* (PPB) interface provides access to:

- the *Instrumentation Trace Macrocell* (ITM)
- the *Data Watchpoint and Trace* (DWT)
- the *Flashpatch and Breakpoint* (FPB)
- the *System Control Space* (SCS), including the Memory Protection Unit (MPU) and the Nested Vectored Interrupt Controller (NVIC).

The external PPB interface provides access to:

- the *Trace Point Interface Unit* (TPIU)
- the *Embedded Trace Macrocell* (ETM)
- the ROM table.
- implementation-specific areas of the PPB memory map.

### 3.4.2 Unaligned accesses that cross regions

The Cortex-M4 processor supports ARMv7 unaligned accesses, and performs all accesses as single, unaligned accesses. They are converted into two or more aligned accesses by the DCode and System bus interfaces.

———— **Note** —————

All Cortex-M4 external accesses are aligned.

Unaligned support is only available for load/store singles (LDR, STR). Load/store double already supports word aligned accesses, but does not permit other unaligned accesses, and generates a fault if this is attempted.



Unaligned accesses that cross memory map boundaries are architecturally Unpredictable. The processor behavior is boundary dependent, as follows:

- DCode accesses wrap within the region. For example, an unaligned halfword access to the last byte of Code space (0x1FFFFFFF) is converted by the DCode interface into a byte access to 0x1FFFFFFF followed by a byte access to 0x00000000.
- System accesses that cross into PPB space do not wrap within System space. For example, an unaligned halfword access to the last byte of System space (0xDFFFFFFF) is converted by the System interface into a byte access to 0xDFFFFFFF followed by a byte access to 0xE0000000. 0xE0000000 is not a valid address on the System bus.
- System accesses that cross into Code space do not wrap within System space. For example, an unaligned halfword access to the last byte of System space (0xFFFFFFFF) is converted by the System interface into a byte access to 0xFFFFFFFF followed by a byte access to 0x00000000. 0x00000000 is not a valid address on the System bus.
- Unaligned accesses are not supported to PPB space, and so there are no boundary crossing cases for PPB accesses.

Unaligned accesses that cross into the bit-band alias regions are also architecturally Unpredictable. The processor performs the access to the bit-band alias address, but this does not result in a bit-band operation. For example, an unaligned halfword access to 0x21FFFFFF is performed as a byte access to 0x21FFFFFF followed by a byte access to 0x22000000 (the first byte of the bit-band alias).

Unaligned loads that match against a literal comparator in the FPB are not remapped. FPB only remaps aligned addresses.

### 3.5 Write buffer

To prevent bus wait cycles from stalling the processor during data stores, buffered stores to the DCode and System buses go through a one-entry write buffer. If the write buffer is full, subsequent accesses to the bus stall until the write buffer has drained. The write buffer is only used if the bus waits the data phase of the buffered store, otherwise the transaction completes on the bus.

DMB and DSB instructions wait for the write buffer to drain before completing. If an interrupt comes in while DMB or DSB is waiting for the write buffer to drain, the processor returns to the instruction following the DMB or DSB after the interrupt completes. This is because interrupt processing acts as a memory barrier operation.

## 3.6 Exclusive monitor

The Cortex-M4 processor implements a local exclusive monitor. For more information about semaphores and the local exclusive monitor see the *ARMv7M ARM Architecture Reference Manual*.

## 3.7 Bit-banding

Bit-banding is an optional feature of the Cortex-M4 processor. Bit-banding maps a complete word of memory onto a single bit in the bit-band region. For example, writing to one of the alias words sets or clears the corresponding bit in the bit-band region. This enables every individual bit in the bit-banding region to be directly accessible from a word-aligned address using a single LDR instruction. It also enables individual bits to be toggled without performing a read-modify-write sequence of instructions.

The processor memory map includes two bit-band regions. These occupy the lowest 1MB of the SRAM and Peripheral memory regions respectively. These bit-band regions map each word in an alias region of memory to a bit in a bit-band region of memory.

The System bus interface contains logic that controls bit-band accesses as follows:

- It remaps bit-band alias addresses to the bit-band region.
- For reads, it extracts the requested bit from the read byte, and returns this in the *Least Significant Bit* (LSB) of the read data returned to the core.
- For writes, it converts the write to an atomic read-modify-write operation.
- The processor does not stall during bit-band operations unless it attempts to access the System bus while the bit-band operation is being carried out.

The memory map has two 32-MB alias regions that map to two 1-MB bit-band regions:

- Accesses to the 32-MB SRAM alias region map to the 1-MB SRAM bit-band region.
- Accesses to the 32-MB peripheral alias region map to the 1-MB peripheral bit-band region.

A mapping formula shows how to reference each word in the alias region to a corresponding bit, or target bit, in the bit-band region. The mapping formula is:

$$\text{bit\_word\_offset} = (\text{byte\_offset} \times 32) + (\text{bit\_number} \times 4)$$

$$\text{bit\_word\_addr} = \text{bit\_band\_base} + \text{bit\_word\_offset}$$

where:

- `bit_word_offset` is the position of the target bit in the bit-band memory region.
- `bit_word_addr` is the address of the word in the alias memory region that maps to the targeted bit.
- `bit_band_base` is the starting address of the alias region.
- `byte_offset` is the number of the byte in the bit-band region that contains the targeted bit.
- `bit_number` is the bit position, 0 to 7, of the targeted bit.

Figure 3-2 on page 3-20 shows examples of bit-band mapping between the SRAM bit-band alias region and the SRAM bit-band region:

- The alias word at `0x23FFFFE0` maps to bit [0] of the bit-band byte at `0x200FFFFF`: `0x23FFFFE0 = 0x22000000 + (0xFFFF*32) + 0*4`.
- The alias word at `0x23FFFFFC` maps to bit [7] of the bit-band byte at `0x200FFFFF`: `0x23FFFFFC = 0x22000000 + (0xFFFF*32) + 7*4`.
- The alias word at `0x22000000` maps to bit [0] of the bit-band byte at `0x20000000`: `0x22000000 = 0x22000000 + (0*32) + 0*4`.

- The alias word at 0x2200001C maps to bit [7] of the bit-band byte at 0x20000000:  $0x2200001C = 0x22000000 + (0*32) + 7*4$ .

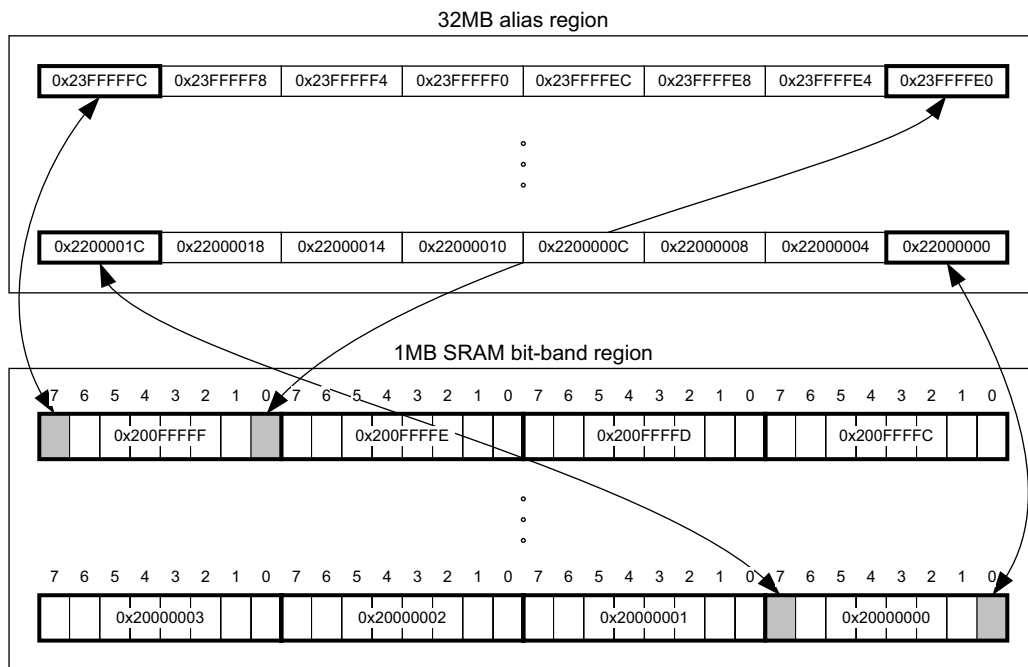

Figure 3-2 Bit-band mapping

### 3.7.1 Directly accessing an alias region

Writing to a word in the alias region has the same effect as a read-modify-write operation on the targeted bit in the bit-band region.

Bit [0] of the value written to a word in the alias region determines the value written to the targeted bit in the bit-band region. Writing a value with bit [0] set writes a 1 to the bit-band bit, and writing a value with bit [0] cleared writes a 0 to the bit-band bit.

Bits [31:1] of the alias word have no effect on the bit-band bit. Writing 0x01 has the same effect as writing 0xFF. Writing 0x00 has the same effect as writing 0x0E.

Reading a word in the alias region returns either 0x01 or 0x00. A value of 0x01 indicates that the targeted bit in the bit-band region is set. A value of 0x00 indicates that the targeted bit is clear. Bits [31:1] are zero.

### 3.7.2 Directly accessing a bit-band region

You can directly access the bit-band region with normal reads and writes to that region.

### 3.8 Processor core register summary

The processor has the following 32-bit registers:

- 13 general-purpose registers, r0-r12
- *Stack Pointer* (SP) alias of banked registers, SP\_process and SP\_main
- *Link Register* (LR), r14
- *Program Counter* (PC), r15
- Special-purpose *Program Status Registers*, (xPSR).

Figure 3-3 shows the processor register set.

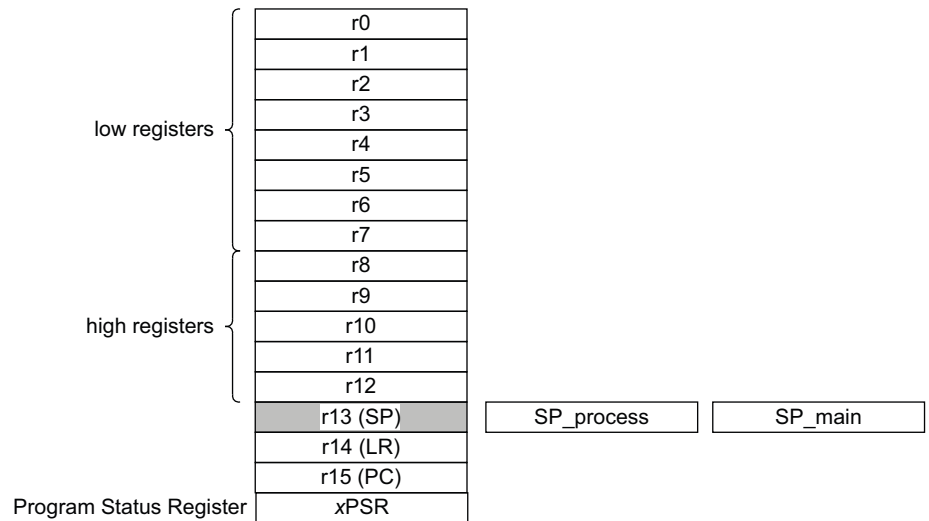

**Figure 3-3 Processor register set**

The general-purpose registers r0-r12 have no special architecturally-defined uses. Most instructions that can specify a general-purpose register can specify r0-r12.

**Low registers** Registers r0-r7 are accessible by all instructions that specify a general-purpose register.

**High registers** Registers r8-r12 are accessible by all 32-bit instructions that specify a general-purpose register.  
Registers r8-r12 are not accessible by all 16-bit instructions.

Registers r13, r14, and r15 have the following special functions:

**Stack pointer** Register r13 is used as the *Stack Pointer* (SP). Because the SP ignores writes to bits [1:0], it is autoaligned to a word, four-byte boundary.  
Handler mode always uses SP\_main, but you can configure Thread mode to use either SP\_main or SP\_process.

**Link register** Register r14 is the subroutine *Link Register* (LR).  
The LR receives the return address from PC when a *Branch and Link* (BL) or *Branch and Link with Exchange* (BLX) instruction is executed.  
The LR is also used for exception return.  
At all other times, you can treat r14 as a general-purpose register.

**Program counter** Register r15 is the *Program Counter* (PC).

Bit [0] is always 0, so instructions are always aligned to word or halfword boundaries.

See the *ARMv7-M Architecture Reference Manual* for more information.

## 3.9 Exceptions

The processor and the *Nested Vectored Interrupt Controller* (NVIC) prioritize and handle all exceptions. When handling exceptions:

- All exceptions are handled in Handler mode.
- Processor state is automatically stored to the stack on an exception, and automatically restored from the stack at the end of the *Interrupt Service Routine* (ISR).
- The vector is fetched in parallel to the state saving, enabling efficient interrupt entry.

The processor supports tail-chaining that enables back-to-back interrupts without the overhead of state saving and restoration.

You configure the number of interrupts, and bits of interrupt priority, during implementation. Software can choose only to enable a subset of the configured number of interrupts, and can choose how many bits of the configured priorities to use.

———— **Note** —————

Vector table entries are compatible with interworking between ARM and Thumb instructions. This causes bit [0] of the vector value to load into the *Execution Program Status Register* (EPSR) T-bit on exception entry. All vector table entries must have bit [0] set. Creating a table entry with bit [0] clear generates an INVSTATE fault on the first instruction of the handler corresponding to this vector.

### 3.9.1 Exception handling

The processor implements advanced exception and interrupt handling, as described in the *ARMv7-M Architecture Reference Manual*.

To reduce interrupt latency, the processor implements both interrupt late-arrival and interrupt tail-chaining mechanisms, as defined by the ARMv7-M architecture:

- There is a maximum of a 12 cycle latency from asserting the interrupt to execution of the first instruction of the ISR when the memory being accessed has no wait states being applied. The first instruction to be executed is fetched in parallel to the stack push.
- Returns from interrupts similarly take twelve cycles where the instruction being returned to is fetched in parallel to the stack pop.
- Tail chaining requires 6 cycles when using zero wait state memory. No stack pushes or pops are performed and only the instruction for the next ISR is fetched.

The processor exception model has the following implementation-defined behavior in addition to the architecturally defined behavior:

- exceptions on stacking from HardFault to NMI lockup at NMI priority
- exceptions on unstacking from NMI to HardFault lockup at HardFault priority.

To minimize interrupt latency, the processor abandons any divide instruction to take any pending interrupt. On return from the interrupt handler, the processor restarts the divide instruction from the beginning. The processor implements the Interruptible-continuable Instruction field. Load multiple (LDM) operations and store multiple (STM) operations are interruptible. The ICI field of the EPSR holds the information required to continue the load or store multiple from the point where the interrupt occurred.



This means that software must not use load-multiple or store-multiple instructions to access a device or memory region that is read-sensitive or sensitive to repeated writes. The software must not use these instructions in any case where repeated reads or writes might cause inconsistent results or unwanted side-effects.

### **Base register update in LDM and STM operations**

There are cases when an LDM or STM updates the base register:

- When the instruction specifies base register write-back, the base register changes to the updated address. An abort restores the original base value.
- When the base register is in the register list of an LDM, and is not the last register in the list, the base register changes to the loaded value.

An LDM or STM is restarted rather than continued if:

- the instruction faults
- the instruction is inside an IT.

If an LDM has completed a base load, it is continued from before the base load.

# Chapter 4

## System Control

This chapter describes the registers that program the processor. It contains the following sections:

- *About system control* on page 4-2
- *Register summary* on page 4-3
- *Register descriptions* on page 4-5.

## 4.1 About system control

This chapter describes the registers that control the operation of the processor.

## 4.2 Register summary

Table 4-1 shows the system control registers. Registers not described in this chapter are described in the *ARMv7-M Architecture Reference Manual*

**Table 4-1 System control registers**

Address	Name	Type	Reset	Description
0xE000E008	ACTLR	RW	0x00000000	Auxiliary Control Register, <i>ACTLR</i> on page 4-5
0xE000E010	STCSR	RW	0x00000000	SysTick Control and Status Register
0xE000E014	STRVR	RW	Unknown	SysTick Reload Value Register
0xE000E018	STCVR	RW clear	Unknown	SysTick Current Value Register
0xE000E01C	STCR	RO	STCALIB	SysTick Calibration Value Register
0xE000ED00	CPUID	RO	0x410FC240	<i>CPUID Base Register</i> , <i>CPUID</i> on page 4-5
0xE000ED04	ICSR	RW or RO	0x00000000	Interrupt Control and State Register
0xE000ED08	VTOR	RW	0x00000000	Vector Table Offset Register
0xE000ED0C	AIRCR	RW	0x00000000 <sup>a</sup>	Application Interrupt and Reset Control Register
0xE000ED10	SCR	RW	0x00000000	System Control Register
0xE000ED14	CCR	RW	0x00000200	Configuration and Control Register.
0xE000ED18	SHPR1	RW	0x00000000	System Handler Priority Register 1
0xE000ED1C	SHPR2	RW	0x00000000	System Handler Priority Register 2
0xE000ED20	SHPR3	RW	0x00000000	System Handler Priority Register 3
0xE000ED24	SHCSR	RW	0x00000000	System Handler Control and State Register
0xE000ED28	CFSR	RW	0x00000000	Configurable Fault Status Registers
0xE000ED2C	HFSR	RW	0x00000000	HardFault Status register
0xE000ED30	DFSR	RW	0x00000000	Debug Fault Status Register
0xE000ED34	MMFAR	RW	Unknown	MemManage Address Register <sup>b</sup>
0xE000ED38	BFAR	RW	Unknown	BusFault Address Register <sup>b</sup>
0xE000ED3C	AFSR	RW	0x00000000	<i>Auxiliary Fault Status Register</i> , <i>AFSR</i> on page 4-6
0xE000ED40	ID_PFR0	RO	0x00000030	Processor Feature Register 0
0xE000ED44	ID_PFR1	RO	0x00000200	Processor Feature Register 1
0xE000ED48	ID_DFR0	RO	0x00100000	Debug Features Register 0
0xE000ED4C	ID_AFR0	RO	0x00000000	Auxiliary Features Register 0
0xE000ED50	ID_MMFR0	RO	0x00000030	Memory Model Feature Register 0
0xE000ED54	ID_MMFR1	RO	0x00000000	Memory Model Feature Register 1
0xE000ED58	ID_MMFR2	RO	0x00000000	Memory Model Feature Register 2
0xE000ED5C	ID_MMFR3	RO	0x00000000	Memory Model Feature Register 3
0xE000ED60	ID_ISAR0	RO	0x01141110	Instruction Set Attributes Register 0

**Table 4-1 System control registers (continued)**

Address	Name	Type	Reset	Description
0xE000ED64	ID_ISAR1	RO	0x02112000	Instruction Set Attributes Register 1
0xE000ED68	ID_ISAR2	RO	0x21232231	Instruction Set Attributes Register 2
0xE000ED6C	ID_ISAR3	RO	0x01111131	Instruction Set Attributes Register 3
0xE000ED70	ID_ISAR4	RO	0x01310102	Instruction Set Attributes Register 4
0xE000ED88	CPACR	RW	-	Coprocessor Access Control Register
0xE000EF00	STIR	WO	0x00000000	Software Triggered Interrupt Register

- a. Bits [10:8] are reset to zero. The ENDIANNESS bit, bit [15], can reset to either state, depending on the implementation.
- b. BFAR and MFAR are the same physical register. Because of this, the BFARVALID and MFAEVALID bits are mutually exclusive.

## 4.3 Register descriptions

This section describes the system control registers whose implementation is specific to this processor.

### 4.3.1 Auxiliary Control Register, ACTLR

The ACTLR characteristics are:

**Purpose** Disables certain aspects of functionality within the processor.

**Usage Constraints** There are no usage constraints.

**Configurations** This register is available in all processor configurations.

**Attributes** See the register summary in Table 4-1 on page 4-3.

Figure 4-1 shows the ACTLR bit assignments.

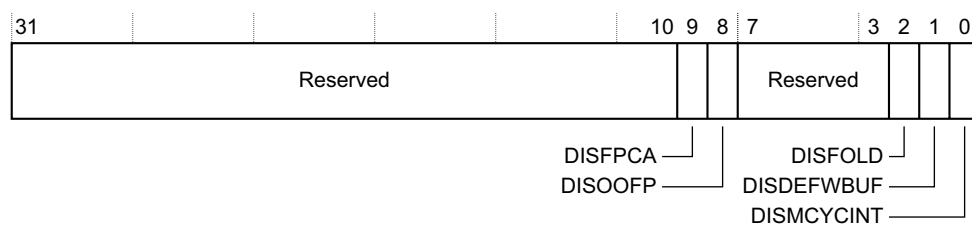

Figure 4-1 ACTLR bit assignments

Table 4-2 shows the ACTLR bit assignments.

Table 4-2 ACTLR bit assignments

Bits	Name	Function
[31:10]	-	Reserved
[9]	DISFPCA	Disables lazy stacking of floating point context. See <i>Exceptions</i> on page 7-8 for more information.
[8]	DISOFP	Disables floating point instructions completing out of order with respect to integer instructions.
[7:3]	-	Reserved
[2]	DISFOLD	Disables folding of IT instructions.
[1]	DISDEFWBUF	Disables write buffer use during default memory map accesses. This causes all bus faults to be precise, but decreases the performance of the processor because stores to memory must complete before the next instruction can be executed.
[0]	DISMCYCINT	Disables interruption of multi-cycle instructions. This increases the interrupt latency of the processor because load/store and multiply/divide operations complete before interrupt stacking occurs.

### 4.3.2 CPUID Base Register, CPUID

The CPUID characteristics are:

**Purpose** Specifies:

- the ID number of the processor core

- the version number of the processor core
- the implementation details of the processor core.

**Usage Constraints** There are no usage constraints.

**Configurations** This register is available in all processor configurations.

**Attributes** See the register summary in Table 4-1 on page 4-3.

Figure 4-2 shows the CPUID bit assignments.

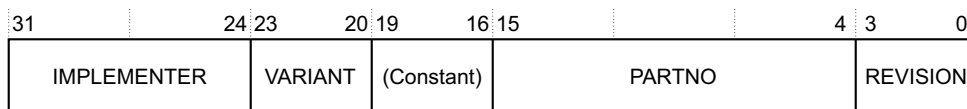

**Figure 4-2 CPUID bit assignments**

Table 4-3 shows the CPUID bit assignments.

**Table 4-3 CPUID bit assignments**

Bits	NAME	Function
[31:24]	IMPLEMENTER	Indicates implementor: 0x41 = ARM
[23:20]	VARIANT	Indicates processor revision: 0x0 = Revision 0
[19:16]	(Constant)	Reads as 0xF
[15:4]	PARTNO	Indicates part number: 0xC24 = Cortex-M4
[3:0]	REVISION	Indicates patch release: 0x0 = Patch 0.

### 4.3.3 Auxiliary Fault Status Register, AFSR

The AFSR characteristics are:

**Purpose** Specifies additional system fault information to software.

**Usage Constraints** The AFSR flags map directly onto the AUXFAULT inputs of the processor, and a single-cycle high level on an external pin causes the corresponding AFSR bit to become latched as one. The bit can only be cleared by writing a one to the corresponding AFSR bit.

When an AFSR bit is written or latched as one, an exception does not occur. If you require an exception, you must use an interrupt.

**Configurations** This register is available in all processor configurations.

**Attributes** See the register summary in Table 4-1 on page 4-3.

Figure 4-3 shows the AFSR bit assignments.

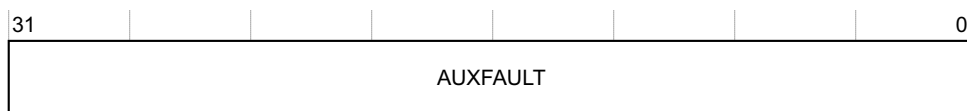

**Figure 4-3 AFSR bit assignments**

Table 4-4 shows the AFSR bit assignments.

**Table 4-4 AFSR bit assignments**

<b>Bits</b>	<b>Name</b>	<b>Function</b>
[31:0]	AUXFAULT	Latched version of the AUXFAULT inputs.



# Chapter 5

## Memory Protection Unit

This chapter describes the processor *Memory Protection Unit* (MPU). It contains the following sections:

- *About the MPU* on page 5-2
- *MPU functional description* on page 5-3
- *MPU programmers model* on page 5-4.

## 5.1 About the MPU

The MPU is an optional component for memory protection. The processor supports the standard *ARMv7 Protected Memory System Architecture* model. The MPU provides full support for:

- protection regions
- overlapping protection regions, with ascending region priority:
  - 7 = highest priority
  - 0 = lowest priority.
- access permissions
- exporting memory attributes to the system.

MPU mismatches and permission violations invoke the programmable-priority MemManage fault handler. See the *ARMv7-M Architecture Reference Manual* for more information.

You can use the MPU to:

- enforce privilege rules
- separate processes
- enforce access rules.

## 5.2 MPU functional description

The access permission bits, TEX, C, B, AP, and XN, of the Region Access Control Register control access to the corresponding memory region. If an access is made to an area of memory without the required permissions, then a permission fault is raised. For more information, see the *ARMv7-M Architecture Reference Manual*.

### 5.3 MPU programmers model

Table 5-5 shows the MPU registers. These registers are described in the *ARMv7-M Architecture Reference Manual*.

**Table 5-1 MPU registers**

Address	Name	Type	Reset	Description
0xE000ED90	MPU_TYPE	RO	0x00000800	MPU Type Register
0xE000ED94	MPU_CTRL	RW	0x00000000	MPU Control Register
0xE000ED98	MPU_RNR	RW	-	MPU Region Number Register
0xE000ED9C	MPU_RBAR	RW	-	MPU Region Base Address Register
0xE000EDA0	MPU_RASR	RW	-	MPU Region Attribute and Size Register
0xE000EDA4	MPU_RBAR_A1		-	MPU alias registers
0xE000EDA8	MPU_RASR_A1		-	
0xE000EDAC	MPU_RBAR_A2		-	
0xE000EDB0	MPU_RASR_A2		-	
0xE000EDB4	MPU_RBAR_A3		-	
0xE000EDB8	MPU_RASR_A3		-	

# Chapter 6

## **Nested Vectored Interrupt Controller**

This chapter describes the *Nested Vectored Interrupt Controller* (NVIC). It contains the following sections:

- *About the NVIC* on page 6-2
- *NVIC functional description* on page 6-3
- *NVIC programmers model* on page 6-4.

## 6.1 About the NVIC

The NVIC provides configurable interrupt handling abilities to the processor. It:

- facilitates low-latency exception and interrupt handling
- controls power management

## 6.2 NVIC functional description

The NVIC supports up to 240 interrupts each with up to 256 levels of priority. You can change the priority of an interrupt dynamically. The NVIC and the processor core interface are closely coupled, to enable low latency interrupt processing and efficient processing of late arriving interrupts. The NVIC maintains knowledge of the stacked, or nested, interrupts to enable tail-chaining of interrupts.

You can only fully access the NVIC from privileged mode, but you can cause interrupts to enter a pending state in user mode if you enable the Configuration Control Register. Any other user mode access causes a bus fault.

You can access all NVIC registers using byte, halfword, and word accesses unless otherwise stated. NVIC registers are located within the SCS.

All NVIC registers and system debug registers are little-endian regardless of the endianness state of the processor.

Processor exception handling is described in *Exceptions* on page 3-23.

### 6.2.1 Low power modes

Your implementation can include a *Wake-up Interrupt Controller* (WIC). This enables the processor and NVIC to be put into a very low-power sleep mode leaving the WIC to identify and prioritize interrupts.

The processor fully implements the *Wait For Interrupt* (WFI), *Wait For Event* (WFE) and the *Send Event* (SEV) instructions. In addition, the processor also supports the use of SLEEPONEXIT, that causes the processor core to enter sleep mode when it returns from an exception handler to Thread mode. See the *ARMv7-M Architecture Reference Manual* for more information.

### 6.2.2 Level versus pulse interrupts

The processor supports both level and pulse interrupts. A level interrupt is held asserted until it is cleared by the ISR accessing the device. A pulse interrupt is a variant of an edge model. You must ensure that the pulse is sampled on the rising edge of the Cortex-M4 clock, **FCLK**, instead of being asynchronous.

For level interrupts, if the signal is not deasserted before the return from the interrupt routine, the interrupt again enters the pending state and re-activates. This is particularly useful for FIFO and buffer-based devices because it ensures that they drain either by a single ISR or by repeated invocations, with no extra work. This means that the device holds the signal in assert until the device is empty.

A pulse interrupt can be reasserted during the ISR so that the interrupt can be in the pending state and active at the same time. The application design must ensure that a second pulse does not arrive before the first pulse is activated. The second entry to the pending state has no affect because it is already in that state. However, if the interrupt is asserted for at least one cycle, the NVIC latches the pend bit. When the ISR activates, the pend bit is cleared. If the interrupt asserts again while it is activated, it can latch the pend bit again.

Pulse interrupts are mostly used for external signals and for rate or repeat signals.

## 6.3 NVIC programmers model

Table 6-1 shows the NVIC registers.

**Table 6-1 NVIC registers**

Address	Name	Type	Reset	Description
0xE000E004	ICTR	RO	-	<i>Interrupt Controller Type Register, ICTR</i>
0xE000E100 - 0xE000E11C	NVIC_ISER0 - NVIC_ISER7	RW	0x00000000	Interrupt Set-Enable Registers
0xE000E180 - 0xE000E19C	NVIC_ICER0 - NVIC_ICER7	RW	0x00000000	Interrupt Clear-Enable Registers
0xE000E200 - 0xE000E21C	NVIC_ISPR0 - NVIC_ISPR7	RW	0x00000000	Interrupt Set-Pending Registers
0xE000E280 - 0xE000E29C	NVIC_ICPR0 - NVIC_ICPR7	RW	0x00000000	Interrupt Clear-Pending Registers
0xE000E300 - 0xE000E31C	NVIC_IABR0 - NVIC_IABR7	RO	0x00000000	Interrupt Active Bit Register
0xE000E400 - 0xE000E41F	NVIC_IPR0 - NVIC_IPR59	RW	0x00000000	Interrupt Priority Register

The following sections describe the NVIC registers whose implementation is specific to this processor. Other registers are described in the *ARMv7M Architecture Reference Manual*.

### 6.3.1 Interrupt Controller Type Register, ICTR

The ICTR characteristics are:

**Purpose** Shows the number of interrupt lines that the NVIC supports.

**Usage Constraints** There are no usage constraints.

**Configurations** This register is available in all processor configurations.

**Attributes** See the register summary in Table 6-1.

Figure 6-1 shows the ICTR bit assignments.

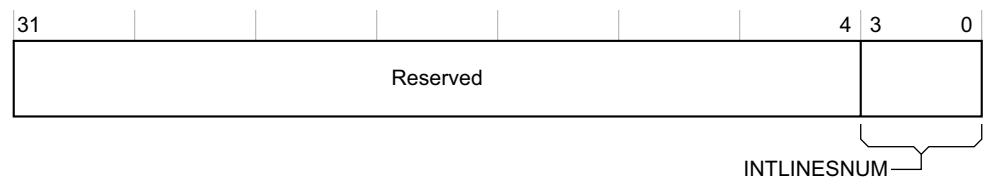

**Figure 6-1 ICTR bit assignments**



Table 6-2 shows the ICTR bit assignments.

**Table 6-2 ICTR bit assignments**

Bits	Name	Function
[31:4]	-	Reserved.
[3:0]	INTLINESNUM	Total number of interrupt lines in groups of 32: b0000 = 0...32 b0001 = 33...64 b0010 = 65...96 b0011 = 97...128 b0100 = 129...160 b0101 = 161...192 b0110 = 193...224 b0111 = 225...256 <sup>a</sup>

a. The processor supports a maximum of 240 external interrupts.

# Chapter 7

## Floating Point Unit

This chapter describes the programmer's model of the *Floating Point Unit* (FPU). It contains the following sections:

- *About the FPU* on page 7-2
- *FPU Functional Description* on page 7-3
- *FPU Programmers Model* on page 7-9

The Cortex-M4F processor is a Cortex-M4 processor that includes the optional FPU. In this chapter, the generic term *processor* means only the Cortex-M4F processor.

## 7.1 About the FPU

The Cortex-M4 FPU is an implementation of the single precision variant of the ARMv7-M Floating-Point Extension (FPv4-SP). It provides floating-point computation functionality that is compliant with the *ANSI/IEEE Std 754-2008, IEEE Standard for Binary Floating-Point Arithmetic*, referred to as the IEEE 754 standard. The FPU supports all single-precision data-processing instructions and data types described in the *ARM Architecture Reference Manual*.

## 7.2 FPU Functional Description

The FPU fully supports single-precision add, subtract, multiply, divide, multiply and accumulate, and square root operations. It also provides conversions between fixed-point and floating-point data formats, and floating-point constant instructions

The FPU functional description includes the following topics:

- *FPU views of the register bank*
- *Modes of operation*
- *FPU instruction set* on page 7-4
- *Compliance with the IEEE 754 standard* on page 7-6
- *Complete implementation of the IEEE 754 standard* on page 7-6
- *IEEE 754 standard implementation choices* on page 7-6
- *Exceptions* on page 7-8
- *Enabling the FPU* on page 7-9

### 7.2.1 FPU views of the register bank

The FPU provides an extension register file containing 32 single-precision registers. These can be viewed as:

- Sixteen 64-bit doubleword registers, D0-D15.
- Thirty-two 32-bit single-word registers, S0-S31.
- A combination of registers from the above views.

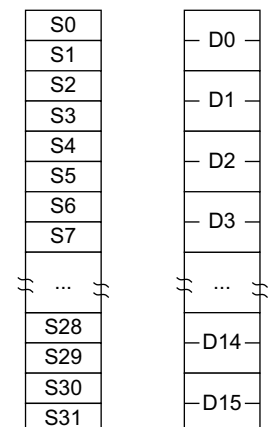

Figure 7-1 FPU register bank

The mapping between the registers is as follows:

- S<2n> maps to the least significant half of D<n>
- S<2n+1> maps to the most significant half of D<n>.

For example, you can access the least significant half of the value in D6 by accessing S12, and the most significant half of the elements by accessing S13.

### 7.2.2 Modes of operation

The FPU provides three modes of operation to accommodate a variety of applications:

- *Full-compliance mode* on page 7-4
- *Flush-to-zero mode* on page 7-4
- *Default NaN mode* on page 7-4

### Full-compliance mode

In full-compliance mode, the FPU processes all operations according to the IEEE 754 standard in hardware.

### Flush-to-zero mode

Setting the FZ bit, FPSCR[24], enables flush-to-zero mode. In this mode, the FPU treats all subnormal input operands of arithmetic CDP operations as zeros in the operation. Exceptions that result from a zero operand are signaled appropriately. VABS, VNEG, and VMOV are not considered arithmetic CDP operations and are not affected by flush-to-zero mode. A result that is *tiny*, as described in the IEEE 754 standard, for the destination precision is smaller in magnitude than the minimum normal value *before rounding* and is replaced with a zero. The IDC flag, FPSCR[7], indicates when an input flush occurs. The UFC flag, FPSCR[3], indicates when a result flush occurs.

### Default NaN mode

Setting the DN bit, FPSCR[25], enables default NaN mode. In this mode, the result of any arithmetic data processing operation that involves an input NaN, or that generates a NaN result, returns the default NaN. Propagation of the fraction bits is maintained only by VABS, VNEG, and VMOV operations. All other CDP operations ignore any information in the fraction bits of an input NaN.

## 7.2.3 FPU instruction set

Table 7-1 shows the instruction set of the FPU.

Table 7-1 FPU instruction set

Operation	Description	Assembler	Cycles
Absolute value	of float	VABS.F32	1
Addition	floating point	VADD.F32	1
Compare	float with register or zero	VCMP.F32	1
	float with register or zero	VCMP.E.F32	1
Convert	between integer, fixed-point, half-precision and float	VCVT.F32	1
Divide	Floating-point	VDIV.F32	14
Load	multiple doubles	VLDM.64	1+2*N, where N is the number of doubles.
	multiple floats	VLDM.32	1+N, where N is the number of floats.
	single double	VLDR.64	3
	single float	VLDR.32	2

Table 7-1 FPU instruction set (continued)

Operation	Description	Assembler	Cycles
Move	top/bottom half of double to/from core register	VMOV	1
	immediate/float to float-register	VMOV	1
	two floats/one double to/from two core registers or one float to/from one core register	VMOV	2
	floating-point control/status to core register	VMRS	1
	core register to floating-point control/status	VMSR	1
Multiply	float	VMUL.F32	1
	then accumulate float	VMLA.F32	3
	then subtract float	VMLS.F32	3
	then accumulate then negate float	VNMLA.F32	3
	then subtract then negate float	VNMLS.F32	3
Multiply (fused)	then accumulate float	VFMA.F32	3
	then subtract float	VFMS.F32	3
	then accumulate then negate float	VFNMA.F32	3
	then subtract then negate float	VFNMS.F32	3
Negate	float	VNEG.F32	1
	and multiply float	VNMUL.F32	1
Pop	double registers from stack	VPOP.64	1+2*N, where N is the number of double registers.
	float registers from stack	VPOP.32	1+N where N is the number of registers
Push	double registers to stack	VPUSH.64	1+2*N, where N is the number of double registers.
	float registers to stack	VPUSH.32	1+N, where N is the number of registers
Square-root	of float	VSQRT.F32	14
Store	multiple double registers	VSTM.64	1+2*N, where N is the number of doubles.
	multiple float registers	VSTM.32	1+N, where N is the number of floats.
	single double register	VSTR.64	3
	single float registers	VSTR.32	2
Subtract	float	VSUB.F32	1

---

**Note**

---

- Integer-only instructions following VDIVR or VSQRT instructions complete out-of-order. VDIV and VSQRT instructions take one cycle if no further floating-point instructions are executed.
  - Floating-point arithmetic data processing instructions, such as add, subtract, multiply, divide, square-root, all forms of multiply with accumulate, as well as conversions of all types take one cycle longer if their result is consumed by the following instruction.
  - Both fused and chained multiply with accumulate instructions consume their addend one cycle later, so the result of an arithmetic instruction that is followed by a multiply with accumulate instruction is consumed as the addend of the MAC instruction.
- 

### 7.2.4 Compliance with the IEEE 754 standard

When *Default NaN* (DN) and *Flush-to-Zero* (FZ) modes are disabled, FPv4 functionality is compliant with the IEEE 754 standard in hardware. No support code is required to achieve this compliance.

See the *ARM Architecture Reference Manual* for information about FP architecture compliance with the IEEE 754 standard.

### 7.2.5 Complete implementation of the IEEE 754 standard

The Cortex-M4F floating point instruction set does not support all operations defined in the IEEE 754-2008 standard. Unsupported operations include, but are not limited to the following:

- remainder
- round floating-point number to integer-valued floating-point number
- binary-to-decimal conversions
- decimal-to-binary conversions
- direct comparison of single-precision and double-precision values.

The Cortex-M4 FPU supports fused MAC operations as described in the IEEE standard. For complete implementation of the IEEE 754-2008 standard, floating-point functionality must be augmented with library functions.

### 7.2.6 IEEE 754 standard implementation choices

Some of the implementation choices permitted by the IEEE 754-2008 standard and used in the FPv4 architecture are described in the *ARM Architecture Reference Manual*.

#### NaN handling

All single-precision values with the maximum exponent field value and a nonzero fraction field are valid NaNs. A most significant fraction bit of zero indicates a *Signaling NaN* (SNaN). A one indicates a *Quiet NaN* (QNaN). Two NaN values are treated as different NaNs if they differ in any bit. Table 7-2 shows the default NaN values.

**Table 7-2 Default NaN values**

Sign	Fraction	Fraction
0	00xFF	bit [22] = 1, bits [21:0] are all zeros

Processing of input NaNs for ARM floating-point functionality and libraries is defined as follows:

- In full-compliance mode, NaNs are handled as described in the *ARM Architecture Reference Manual*. The hardware processes the NaNs directly for arithmetic CDP instructions. For data transfer operations, NaNs are transferred without raising the Invalid Operation exception. For the non-arithmetic CDP instructions, VABS, VNEG, and VMOV, NaNs are copied, with a change of sign if specified in the instructions, without causing the Invalid Operation exception.
- In default NaN mode, arithmetic CDP instructions involving NaN operands return the default NaN regardless of the fractions of any NaN operands. SNaNs in an arithmetic CDP operation set the IOC flag, FPSCR[0]. NaN handling by data transfer and non-arithmetic CDP instructions is the same as in full-compliance mode.

Table 7-3 summarizes the effects of NaN operands on instruction execution.

**Table 7-3 QNaN and SNaN handling**

Instruction type	Default NaN mode	With QNaN operand	With SNaN operand
Arithmetic CDP	Off	The QNaN or one of the QNaN operands, if there is more than one, is returned according to the rules given in the <i>ARM Architecture Reference Manual</i> .	IOC <sup>a</sup> set. The SNaN is quieted and the result NaN is determined by the rules given in the <i>ARM Architecture Reference Manual</i> .
	On	Default NaN returns.	IOC <sup>a</sup> set. Default NaN returns.
Non-arithmetic CDP	Off	NaN passes to destination with sign changed as appropriate.	
	On		
FCMP(Z)	-	Unordered compare.	IOC set. Unordered compare.
FCMPE(Z)	-	IOC set. Unordered compare.	IOC set. Unordered compare.
Load/store	Off	All NaNs transferred.	
	On		

a. IOC is the Invalid Operation exception flag, FPSCR[0].

## Comparisons

Comparison results modify the flags in the FPSCR. You can use the `MVRS APSR_nzcv` instruction (formerly `FMSTAT`) to transfer the current flags from the FPSCR to the APSR. See the *ARM Architecture Reference Manual* for mapping of IEEE 754-2008 standard predicates to ARM conditions. The flags used are chosen so that subsequent conditional execution of ARM instructions can test the predicates defined in the IEEE standard.

## Underflow

The Cortex-M4F FPU uses the *before rounding* form of *tininess* and the *inexact result* form of *loss of accuracy* as described in the IEEE 754-2008 standard to generate Underflow exceptions.

In flush-to-zero mode, results that are tiny before rounding, as described in the IEEE standard, are flushed to a zero, and the UFC flag, FPSCR[3], is set. See the *ARM Architecture Reference Manual* for information on flush-to-zero mode.



When the FPU is not in flush-to-zero mode, operations are performed on subnormal operands. If the operation does not produce a tiny result, it returns the computed result, and the UFC flag, FPSCR[3], is not set. The IXC flag, FPSCR[4], is set if the operation is inexact. If the operation produces a tiny result, the result is a subnormal or zero value, and the UFC flag, FPSCR[3], is set if the result was also inexact.

### 7.2.7 Exceptions

The FPU sets the cumulative exception status flag in the FPSCR register as required for each instruction, in accordance with the FPUv4 architecture. The FPU does not support user-mode traps. The exception enable bits in the FPSCR read-as-zero, and writes are ignored. The processor also has six output pins, **FPIXC**, **FPUFC**, **FPOFC**, **FPDZC**, **FPIDC**, and **FPIOC**, that each reflect the status of one of the cumulative exception flags. See the *Cortex-M4 Integration and Implementation Manual* for a description of these outputs.

The processor can reduce the exception latency by using lazy stacking. See *Auxiliary Control Register, ACTLR* on page 4-5. This means that the processor reserves space on the stack for the FP state, but does not save that state information to the stack. See the *ARMv7-M Architecture Reference Manual* for more information.

## 7.3 FPU Programmers Model

Table 7-4 shows the FP system registers in the Cortex-M4F FPU.

**Table 7-4 Cortex-M4F Floating Point system registers**

Address	Name	Type	Reset	Description
0xE000EF34	FPCCR	RW	0xC0000000	FP Context Control Register
0xE000EF38	FPCAR	RW	-	FP Context Address Register
0xE000EF3C	FPDSCR	RW	0x00000000	FP Default Status Control Register
0xE000EF40	MVFR0	RO	0x10110021	Media and VFP Feature Register 0, MVFR0
0xE000EF44	MVFR1	RO	0x11000011	Media and VFP Feature Register 1, MVFR1

All Cortex-M4F FPU registers are described in the *ARMv7-M Architecture Reference Manual*.

### 7.3.1 Enabling the FPU

Example 7-1 shows an example code sequence for enabling the FPU in both privileged and user modes. The processor must be in privileged mode to read from and write to the CPACR.

**Example 7-1 Enabling the FPU**

---

```

; CPACR is located at address 0xE000ED88
LDR.W  R0, =0xE000ED88
; Read CPACR
LDR    R1, [R0]
; Set bits 20-23 to enable CP10 and CP11 coprocessors
ORR    R1, R1, #(0xF << 20)
; Write back the modified value to the CPACR
STR    R1, [R0]

```

---

# Chapter 8

## Debug

This chapter describes how to debug and test software running on the processor. It contains the following sections:

- *About debug* on page 8-2
- *About the AHB-AP* on page 8-6
- *About the Flash Patch and Breakpoint Unit (FPB)* on page 8-9.

## 8.1 About debug

The processor implementation determines the debug configuration, including whether debug is implemented. If the processor does not implement debug, no ROM table is present and the halt, breakpoint, and watchpoint functionality is not present.

Basic debug functionality includes processor halt, single-step, processor core register access, Vector Catch, unlimited software breakpoints, and full system memory access. See the *ARMv7-M Architectural Reference Manual* for more information.

The debug option might include:

- a breakpoint unit supporting 2 literal comparators and 6 instruction comparators, or only 2 instruction comparators
- a watchpoint unit supporting 1 or 4 watchpoints.

For processors that implement debug, ARM recommends that a debugger identify and connect to the debug components using the CoreSight debug infrastructure.

Figure 8-1 shows the recommended flow that a debugger can follow to discover the components in the CoreSight debug infrastructure. In this case a debugger reads the peripheral and component ID registers for each CoreSight component in the CoreSight system.

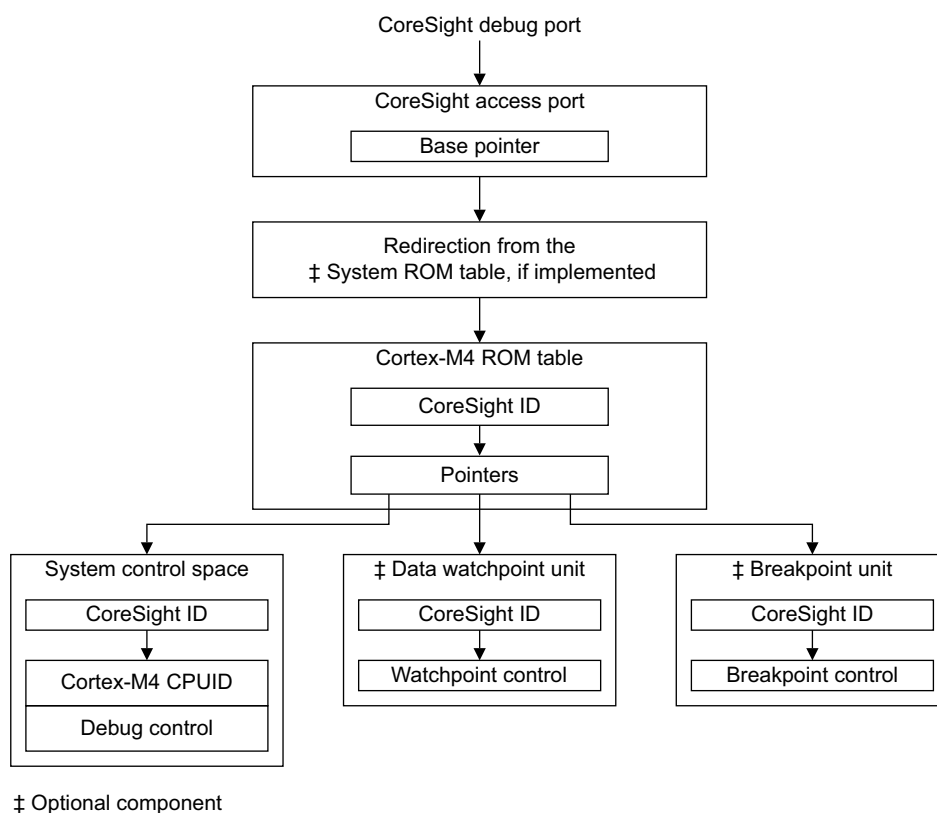

**Figure 8-1 CoreSight discovery**

To identify the Cortex-M4 processor within the CoreSight system, ARM recommends that a debugger perform the following actions:

1. Locate and identify the Cortex-M4 ROM table using its CoreSight identification. See Table 8-1 on page 8-3 for more information.

2. Follow the pointers in that Cortex-M4 ROM table:
  - a. *System Control Space* (SCS)
  - b. *Breakpoint unit* (BPU)
  - c. *Data watchpoint unit* (DWT).

See Table 8-2 for more information.

When a debugger identifies the SCS from its CoreSight identification, it can identify the processor and its revision number from the CPUID register in the SCS at address 0xE000ED00.

A debugger cannot rely on the Cortex-M4 ROM table being the first ROM table encountered. One or more system ROM tables are required between the access port and the Cortex-M4 ROM table if other CoreSight components are in the system. If a system ROM table is present, this can include a unique identifier for the implementation.

### 8.1.1 Cortex-M4 ROM table identification and entries

Table 8-1 shows the ROM table identification registers and values for debugger detection. This permits debuggers to identify the processor and its debug capabilities.

#### ———— Note ————

The Cortex-M4 ROM table only supports word size transactions.

**Table 8-1 Cortex-M4 ROM table identification values**

Address	Register	Value	Description
0xE00FFD0	Peripheral ID4	0x00000004	<i>Component and Peripheral ID register formats in the ARMv7-M Architectural Reference Manual</i>
0xE00FFE0	Peripheral ID0	0x000000C4	
———— Note ————			
0xE00FFE4	Peripheral ID1	0x000000B4	<ul style="list-style-type: none"> <li>• These values for the Peripheral ID registers identify this as a generic ROM table for the Cortex-M4 processor. Your implementation might use these registers to identify the manufacturer and part number for the device.</li> </ul>
0xE00FFE8	Peripheral ID2	0x0000000B	
0xE00FFEC	Peripheral ID3	0x00000000	<ul style="list-style-type: none"> <li>• The Component ID registers identify this as a CoreSight ROM table.</li> </ul>
0xE00FFF0	Component ID0	0x0000000D	
0xE00FFF4	Component ID1	0x00000010	
0xE00FFF8	Component ID2	0x00000005	
0xE00FFFC	Component ID3	0x000000B1	

Table 8-2 shows the CoreSight components that the Cortex-M4 ROM table points to. The values depend on the implemented debug configuration.

**Table 8-2 Cortex-M4 ROM table components**

Address	Component	Value	Description
0xE00FF00	SCS	0xFFF0F003	See <i>System Control Space</i> on page 8-4
0xE00FF04	DWT	0xFFF02003 <sup>a</sup>	See Table 9-1 on page 9-4
0xE00FF08	FPB	0xFFF03003 <sup>b</sup>	See Table 8-7 on page 8-10
0xE00FF0C	ITM	0xFFF01003 <sup>c</sup>	See Table 10-1 on page 10-4

Table 8-2 Cortex-M4 ROM table components (continued)

Address	Component	Value	Description
0xE00FF010	TPIU	0xFFFF41003 <sup>d</sup>	See Table 11-1 on page 11-5
0xE00FF014	ETM	0xFFFF42003 <sup>e</sup>	See the <i>ETM-M4 Technical Reference Manual</i> .
0xE00FF018	End marker	0x00000000	See <i>DAP accessible ROM table</i> in the <i>ARMv7-M Architectural Reference Manual</i>
0xE00FF0CC	SYSTEM ACCESS	0x00000001	

- a. Reads as 0xFFFF02002 if no watchpoints are implemented.
- b. Reads as 0xFFFF03002 if no breakpoints are implemented.
- c. Reads as 0xFFFF01002 if no ITM is implemented.
- d. Reads as 0xFFFF41002 if no TPIU is implemented.
- e. Reads as 0xFFFF42002 if no ETM is implemented.

The ROM table entries point to the debug components of the processor. The offset for each entry is the offset of that component from the ROM table base address, 0xE00FF000.

See the *ARMv7-M Architectural Reference Manual* and the *ARM CoreSight Components Technical Reference Manual* for more information about the ROM table ID and component registers, and their addresses and access types.

### 8.1.2 System Control Space

If debug is implemented, the processor provides debug through registers in the SCS. See:

- *Debug register summary* on page 8-5
- *System address map* on page 3-14.

#### SCS CoreSight identification

Table 8-3 shows the SCS CoreSight identification registers and values for debugger detection. Final debugger identification of the Cortex-M4 processor is through the CPUID register in the SCS. See *CPUID Base Register, CPUID* on page 4-5.

Table 8-3 SCS identification values

Address	Register	Value	Description
0xE00EFD0	Peripheral ID4	0x00000004	<i>Component and Peripheral ID register formats in the ARMv7-M Architectural Reference Manual</i>
0xE00EFE0	Peripheral ID0	0x0000000C	
0xE00EFE4	Peripheral ID1	0x000000B0	
0xE00EFE8	Peripheral ID2	0x0000000B	
0xE00EFEC	Peripheral ID3	0x00000000	
0xE00EFF0	Component ID0	0x0000000D	
0xE00EFF4	Component ID1	0x000000E0	
0xE00EFF8	Component ID2	0x00000005	
0xE00EFFC	Component ID3	0x000000B1	

See the *ARMv7-M Architectural Reference Manual* and the *ARM CoreSight Components Technical Reference Manual* for more information about the SCS CoreSight identification registers, and their addresses and access types.

### 8.1.3 Debug register summary

Table 8-4 shows the debug registers. Each of these registers is 32 bits wide and is described in the *ARMv7-M Architectural Reference Manual*.

**Table 8-4 Debug registers**

Address	Name	Type	Reset	Description
0xE000ED30	DFSR	RW	0x00000000 <sup>a</sup>	Debug Fault Status Register
0xE000EDF0	DHCSR	RW	0x00000000	Debug Halting Control and Status Register
0xE000EDF4	DCRSR	WO	-	Debug Core Register Selector Register
0xE000EDF8	DCRDR	RW	-	Debug Core Register Data Register
0xE000EDFC	DEMCR	RW	0x00000000	Debug Exception and Monitor Control Register

a. Power-on reset only

Core debug is an optional component. If core debug is removed then halt mode debugging is not supported, and there is no halt, stepping, or register transfer functionality. Debug monitor mode is still supported.

## 8.2 About the AHB-AP

The AHB-AP is a *Memory Access Port* (MEM-AP) as defined in the *ARM Debug Interface v5 Architecture Specification*. The AHB-AP is an optional debug access port into the Cortex-M4 system, and provides access to all memory and registers in the system, including processor registers through the SCS. System access is independent of the processor status. Either SW-DP or SWJ-DP is used to access the AHB-AP.

The AHB-AP is a master into the Bus Matrix. Transactions are made using the AHB-AP programmers model, which generates AHB-Lite transactions into the Bus Matrix.

### 8.2.1 AHB-AP transaction types

The AHB-AP does not perform back-to-back transactions on the bus, and so all transactions are non-sequential. The AHB-AP can perform unaligned and bit-band transactions. The Bus Matrix handles these. The AHB-AP transactions are not subject to MPU lookups. AHB-AP transactions bypass the FPB, and so the FPB cannot remap AHB-AP transactions.

AHB-AP transactions are little-endian.

### 8.2.2 AHB-AP programmers model

Table 8-5 shows the AHB-AP registers. If the AHB-AP is not present, these registers read as zero. Any register that is not specified in this table reads as zero.

**Table 8-5 AHB-AP register summary**

Offset <sup>a</sup>	Name	Type	Reset	Description
0x00	CSW	RW	See register	AHB-AP Control and Status Word Register, CSW
0x04	TAR	RW	-	AHB-AP Transfer Address Register
0x0C	DRW	RW	-	AHB-AP Data Read/Write Register
0x10	BD0	RW	-	AHB-AP Banked Data Register0
0x14	BD1	RW	-	AHB-AP Banked Data Register1
0x18	BD2	RW	-	AHB-AP Banked Data Register2
0x1C	BD3	RW	-	AHB-AP Banked Data Register3
0xF8	DBGDRAR	RO	0xE00FF003	AHB-AP ROM Address Register
0xFC	IDR	RO	0x24770011	AHB-AP Identification Register

a. The offset given in this table is relative to the location of the AHB-AP in the DAP memory space. This space is only visible from the access port. It is not part of the processor memory map.

The following sections describe the AHB-AP registers whose implementation is specific to this processor. Other registers are described in the *CoreSight Components Technical Reference Manual*.

#### AHB-AP Control and Status Word Register, CSW

The CSW characteristics are:

**Purpose** Configures and controls transfers through the AHB interface.

**Usage constraints** There are no usage constraints.



**Configurations** This register is available in all processor configurations.

**Attributes** See the register summary in Table 8-5 on page 8-6.

Figure 8-2 shows the CSW bit assignments.

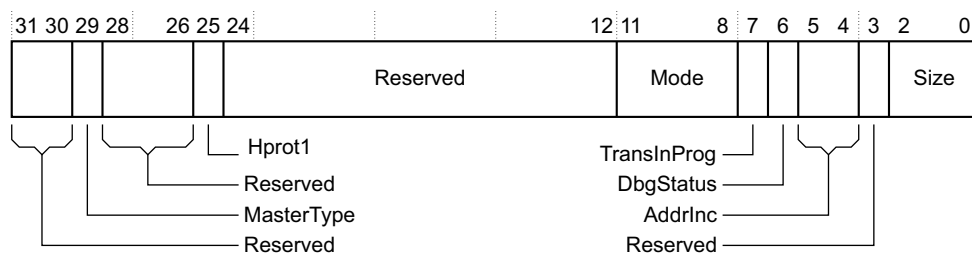

**Figure 8-2 CSW bit assignments**

Table 8-6 shows the CSW bit assignments.

**Table 8-6 CSW bit assignments**

Bits	Name	Function
[31:30]	-	Reserved. Read as 0b00.
[29]	MasterType <sup>a</sup>	0 = core. 1 = debug. This bit must not be changed if a transaction is outstanding. A debugger must first check bit [7], TransInProg. Reset value = 0b1. An implementation can configure this bit to be read only with a value of 1. In that case, transactions are always indicated as debug.
[28:26]	-	Reserved, 0b000.
[25]	Hprot1	User and Privilege control - HPROT[1]. Reset value = 0b1.
[24]	-	Reserved, 0b1.
[23:12]	-	Reserved, 0x000.
[11:8]	Mode	Mode of operation bits: b0000 = normal download and upload mode b0001-b1111 are reserved. Reset value = 0b0000.
[7]	TransInProg	Transfer in progress. This field indicates if a transfer is in progress on the APB master port.
[6]	DbgStatus	Indicates the status of the DAPEN port. 1 = AHB transfers permitted. 0 = AHB transfers not permitted.

Table 8-6 CSW bit assignments (continued)

Bits	Name	Function
[5:4]	AddrInc	<p>Auto address increment and pack mode on Read or Write data access. Only increments if the current transaction completes with no error.</p> <p>Auto address incrementing and packed transfers are not performed on access to Banked Data registers 0x10 - 0x1C. The status of these bits is ignored in these cases.</p> <p>Increments and wraps within a 4-KB address boundary, for example from 0x1000 to 0x1FFC. If the start is at 0x14A0, then the counter increments to 0x1FFC, wraps to 0x1000, then continues incrementing to 0x149C.</p> <p>0b00 = auto increment off.</p> <p>0b01 = increment single. Single transfer from corresponding byte lane.</p> <p>0b10 = increment packed.<sup>b</sup></p> <p>0b11 = reserved. No transfer.</p> <p>Size of address increment is defined by the Size field [2:0].</p> <p>Reset value: 0b00.</p>
[3]	-	Reserved.
[2:0]	Size	<p>Size of access field:</p> <p>b000 = 8 bits</p> <p>b001 = 16 bits</p> <p>b010 = 32 bits</p> <p>b011-111 are reserved.</p> <p>Reset value: b000.</p>

- a. When clear, this bit prevents the debugger from setting the C\_DEBUGEN bit in the Debug Halting Control and Status Register, and so prevents the debugger from being able to halt the processor.
- b. See the definition of packed transfers in the *ARM Debug Interface v5 Architecture Specification*.

## 8.3 About the Flash Patch and Breakpoint Unit (FPB)

The FPB:

- implements hardware breakpoints
- patches code and data from code space to system space.

A full FPB unit contains:

- Two literal comparators for matching against literal loads from Code space, and remapping to a corresponding area in System space.
- Six instruction comparators for matching against instruction fetches from Code space, and remapping to a corresponding area in System space. Alternatively, you can configure the comparators individually to return a *Breakpoint Instruction* (BKPT) to the processor core on a match, to provide hardware breakpoint capability.

A reduced FPB unit contains:

- Two instruction comparators. You can configure each comparator individually to return a Breakpoint Instruction to the processor on a match, to provide hardware breakpoint capability.

### 8.3.1 FPB functional description

The FPB contains both a global enable and individual enables for the eight comparators. If the comparison for an entry matches, the address is either

- remapped to the address set in the remap register plus an offset corresponding to the comparator that matched
- remapped to a BKPT instruction if that feature is enabled.

The comparison happens dynamically, but the result of the comparison occurs too late to stop the original instruction fetch or literal load taking place from the Code space. The processor ignores this transaction however, and only the remapped transaction is used.

If an MPU is present, the MPU lookups are performed for the original address, not the remapped address.

You can remove the FPB if no debug is required, or you can reduce the number of breakpoints it supports to two. If the FPB supports only two breakpoints then only comparators 0 and 1 are used, and the FPB does not support flash patching.

---

#### Note

- Unaligned literal accesses are not remapped. The original access to the DCode bus takes place in this case.
  - Load exclusive accesses can be remapped. However, it is UNPREDICTABLE whether they are performed as exclusive accesses or not.
  - Setting the flash patch remap location to a bit-band alias is not supported and results in UNPREDICTABLE behavior.
-

### 8.3.2 FPB programmers model

Table 8-7 shows the FPB registers. Depending on the implementation of your processor, some of these registers might not be present. Any register that is configured as not present reads as zero.

**Table 8-7 FPB register summary**

Address	Name	Type	Reset	Description
0xE0002000	FP_CTRL	RW	0x130	FlashPatch Control Register
0xE0002004	FP_REMAP	RW	-	FlashPatch Remap Register
0xE0002008	FP_COMP0	RW	1'b0 <sup>a</sup>	FlashPatch Comparator Register0
0xE000200C	FP_COMP1	RW	1'b0	FlashPatch Comparator Register1
0xE0002010	FP_COMP2	RW	1'b0	FlashPatch Comparator Register2
0xE0002014	FP_COMP3	RW	1'b0	FlashPatch Comparator Register3
0xE0002018	FP_COMP4	RW	1'b0	FlashPatch Comparator Register4
0xE000201C	FP_COMP5	RW	1'b0	FlashPatch Comparator Register5
0xE0002020	FP_COMP6	RW	1'b0	FlashPatch Comparator Register6
0xE0002024	FP_COMP7	RW	1'b0	FlashPatch Comparator Register7
0xE0002FD0	PID4	RO	0x04	Peripheral identification registers
0xE0002FD4	PID5	RO	0x00	
0xE0002FD8	PID6	RO	0x00	
0xE0002FDC	PID7	RO	0x00	
0xE0002FE0	PID0	RO	0x03	
0xE0002FE4	PID1	RO	0xB0	
0xE0002FE8	PID2	RO	0x2B	
0xE0002FEC	PID3	RO	0x00	
0xE0002FF0	CID0	RO	0x0D	Component identification registers
0xE0002FF4	CID1	RO	0xE0	
0xE0002FF8	CID2	RO	0x05	
0xE0002FFC	CID3	RO	0xB1	

a. For FP\_COMP0 to FP\_COMP7, bit 0 is reset to 0. Other bits in these registers are not reset.

All FPB registers are described in the *ARMv7-M Architecture Reference Manual*.

# Chapter 9

## Data Watchpoint and Trace Unit

This chapter describes the *Data Watchpoint and Trace* (DWT) unit. It contains the following sections:

- *About the DWT* on page 9-2
- *DWT functional description* on page 9-3
- *DWT Programmers Model* on page 9-4.

## **9.1 About the DWT**

The DWT is an optional debug unit that provides watchpoints, data tracing, and system profiling for the processor.

## 9.2 DWT functional description

A full DWT contains four comparators that you can configure as

- a hardware watchpoint
- an ETM trigger
- a PC sampler event trigger
- a data address sampler event trigger.

The first comparator, DWT\_COMP0, can also compare against the clock cycle counter, CYCCNT. You can also use the second comparator, DWT\_COMP1, as a data comparator.

A reduced DWT contains one comparator that you can use as a watchpoint or as a trigger. It does not support data matching.

The DWT if present contains counters for:

- clock cycles (CYCCNT)
- folded instructions
- *Load Store Unit (LSU)* operations
- sleep cycles
- CPI, that is all instruction cycles except for the first cycle
- interrupt overhead.

---

**Note**

---

An event is generated each time a counter overflows.

---

You can configure the DWT to generate PC samples at defined intervals, and to generate interrupt event information.

The DWT provides periodic requests for protocol synchronization to the ITM and the TPIU, if your implementation includes the Cortex-M4 TPIU.

### 9.3 DWT Programmers Model

Table 9-1 lists the DWT registers. Depending on the implementation of your processor, some of these registers might not be present. Any register that is configured as not present reads as zero.

**Table 9-1 DWT register summary**

Address	Name	Type	Reset	Description
0xE0001000	DWT_CTRL	RW	See <sup>a</sup>	Control Register
0xE0001004	DWT_CYCCNT	RW	0x00000000	Cycle Count Register
0xE0001008	DWT_CPICNT	RW	-	CPI Count Register
0xE000100C	DWT_EXCCNT	RW	-	Exception Overhead Count Register
0xE0001010	DWT_SLEEPCNT	RW	-	Sleep Count Register
0xE0001014	DWT_LSUCNT	RW	-	LSU Count Register
0xE0001018	DWT_FOLDCNT	RW	-	Folded-instruction Count Register
0xE000101C	DWT_PCSR	RO	-	Program Counter Sample Register
0xE0001020	DWT_COMP0	RW	-	Comparator Register0
0xE0001024	DWT_MASK0	RW	-	Mask Register0
0xE0001028	DWT_FUNCTION0	RW	0x00000000	Function Register0
0xE0001030	DWT_COMP1	RW	-	Comparator Register1
0xE0001034	DWT_MASK1	RW	-	Mask Register1
0xE0001038	DWT_FUNCTION1	RW	0x00000000	Function Register1
0xE0001040	DWT_COMP2	RW	-	Comparator Register2
0xE0001044	DWT_MASK2	RW	-	Mask Register2
0xE0001048	DWT_FUNCTION2	RW	0x00000000	Function Register2
0xE0001050	DWT_COMP3	RW	-	Comparator Register3
0xE0001054	DWT_MASK3	RW	-	Mask Register3
0xE0001058	DWT_FUNCTION3	RW	0x00000000	Function Register3
0xE0001FD0	PID4	RO	0x04	Peripheral identification registers
0xE0001FD4	PID5	RO	0x00	
0xE0001FD8	PID6	RO	0x00	
0xE0001FDC	PID7	RO	0x00	
0xE0001FE0	PID0	RO	0x02	
0xE0001FE4	PID1	RO	0xB0	
0xE0001FE8	PID2	RO	0x3B	
0xE0001FEC	PID3	RO	0x00	



Table 9-1 DWT register summary (continued)

Address	Name	Type	Reset	Description
0xE0001FF0	CID0	RO	0x00	Component identification registers
0xE0001FF4	CID1	RO	0xE0	
0xE0001FF8	CID2	RO	0x05	
0xE0001FFC	CID3	RO	0xB1	

a. Possible reset values are:

0x40000000 if four comparators for watchpoints and triggers are present

0x4F000000 if four comparators for watchpoints only are present

0x10000000 if only one comparator is present

0x1F000000 if one comparator for watchpoints and not triggers is present

0x00000000 if DWT is not present.

DWT registers are described in the *ARMv7M Architecture Reference Manual*. Peripheral Identification. Component Identification registers are described in the *ARM CoreSight Components Technical Reference Manual*.

———— **Note** ————

- Cycle matching functionality is only available in comparator 0.
- Data matching functionality is only available in comparator 1.
- Data value is only sampled for accesses that do not produce an MPU or bus fault. The PC is sampled irrespective of any faults. The PC is only sampled for the first address of a burst.
- The FUNCTION field in the DWT\_FUNCTION1 register is overridden for comparators given by DATAVADDR0 and DATAVADDR1 if DATAVMATCH is also set in DWT\_FUNCTION1. The comparators given by DATAVADDR0 and DATAVADDR1 can then only perform address comparator matches for comparator 1 data matches.
- If the data matching functionality is not included during implementation it is not possible to set DATAVADDR0, DATAVADDR1, or DATAVMATCH in DWT\_FUNCTION1. This means that the data matching functionality is not available in the implementation. Test the availability of data matching by writing and reading the DATAVMATCH bit in DWT\_FUNCTION1. If this bit cannot be set then data matching is unavailable.
- PC match is not recommended for watchpoints because it stops after the instruction. It mainly guards and triggers the ETM.

# Chapter 10

## Instrumentation Trace Macrocell Unit

This chapter describes the *Instrumentation Trace Macrocell* (ITM) unit. It contains the following sections:

- *About the ITM* on page 10-2
- *ITM functional description* on page 10-3
- *ITM programmers model* on page 10-4.

## 10.1 About the ITM

The ITM is a an optional application-driven trace source that supports printf style debugging to trace operating system and application events, and generates diagnostic system information.

## 10.2 ITM functional description

The ITM generates trace information as packets. There are four sources that can generate packets. If multiple sources generate packets at the same time, the ITM arbitrates the order in which packets are output. The four sources in decreasing order of priority are:

- Software trace. Software can write directly to ITM stimulus registers to generate packets.
- Hardware trace. The DWT generates these packets, and the ITM outputs them.
- Time stamping. Timestamps are generated relative to packets. The ITM contains a 21-bit counter to generate the timestamp. The Cortex-M4 clock or the bitclock rate of the *Serial Wire Viewer* (SWV) output clocks the counter.
- Global system timestamping. Timestamps can optionally be generated using a system-wide 48-bit count value. The same count value can be used to insert timestamps in the ETM trace stream, allowing coarse-grain correlation.

## 10.3 ITM programmers model

Table 10-1 shows the ITM registers. Depending on the implementation of your processor, the ITM registers might not be present. Any register that is configured as not present reads as zero.

———— **Note** ————

- You must enable TRCENA of the Debug Exception and Monitor Control Register before you program or use the ITM.
- If the ITM stream requires synchronization packets, you must configure the synchronization packet rate in the DWT.

**Table 10-1 ITM register summary**

Address	Name	Type	Reset	Description
0xE0000000- 0xE000007C	ITM_STIM0- ITM_STIM31	RW	-	Stimulus Port Registers 0-31
0xE0000E00	ITM_TER	RW	0x00000000	Trace Enable Register
0xE0000E40	ITM_TPR	RW	0x00000000	<i>ITM Trace Privilege Register; ITM_TPR on page 10-5</i>
0xE0000E80	ITM_TCR	RW	0x00000000	Trace Control Register
0xE0000FD0	PID4	RO	0x00000004	Peripheral Identification registers
0xE0000FD4	PID5	RO	0x00000000	
0xE0000FD8	PID6	RO	0x00000000	
0xE0000FDC	PID7	RO	0x00000000	
0xE0000FE0	PID0	RO	0x00000001	
0xE0000FE4	PID1	RO	0x000000B0	
0xE0000FE8	PID2	RO	0x0000003B	
0xE0000FEC	PID3	RO	0x00000000	
0xE0000FF0	CID0	RO	0x0000000D	Component Identification registers
0xE0000FF4	CID1	RO	0x000000E0	
0xE0000FF8	CID2	RO	0x00000005	
0xE0000FFC	CID3	RO	0x000000B1	

———— **Note** ————

ITM registers are fully accessible in privileged mode. In user mode, all registers can be read, but only the Stimulus Registers and Trace Enable Registers can be written, and only when the corresponding Trace Privilege Register bit is set. Invalid user mode writes to the ITM registers are discarded.

The following sections describes the ITM registers whose implementation is specific to this processor. Other registers are described in the *ARMv7-M Architectural Reference Manual*.

### 10.3.1 ITM Trace Privilege Register, ITM\_TPR

The ITM\_TPR characteristics are:

- Purpose** Enables an operating system to control the stimulus ports that are accessible by user code.
- Usage constraints** You can only write to this register in privileged mode.
- Configurations** This register is available if the ITM is configured in your implementation.
- Attributes** See Table 10-1 on page 10-4.

Figure 10-1 shows the ITM\_TPR bit assignments.

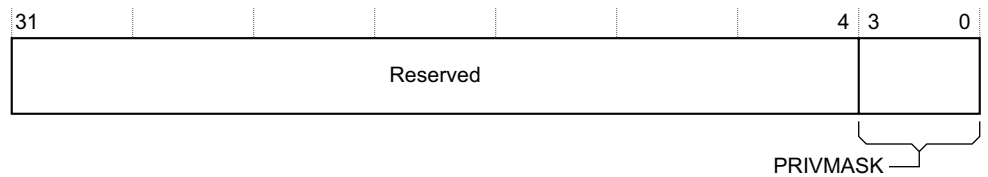

**Figure 10-1 ITM\_TPR bit assignments**

Table 10-2 shows the ITM\_TPR bit assignments.

**Table 10-2 ITM\_TPR bit assignments**

Bits	Name	Function
[31:4]	-	Reserved.
[3:0]	PRIVMASK	Bit mask to enable tracing on ITM stimulus ports: bit [0] = stimulus ports [7:0] bit [1] = stimulus ports [15:8] bit [2] = stimulus ports [23:16] bit [3] = stimulus ports [31:24].

# Chapter 11

## Trace Port Interface Unit

This chapter describes the Cortex-M4 TPIU, the Trace Port Interface Unit that is specific to the Cortex-M4 processor. It contains the following sections:

- *About the Cortex-M4 TPIU* on page 11-2
- *TPIU functional description* on page 11-3
- *TPIU programmers model* on page 11-5.

## 11.1 About the Cortex-M4 TPIU

The Cortex-M4 TPIU is an optional component that acts as a bridge between the on-chip trace data from the *Embedded Trace Macrocell* (ETM) and the *Instrumentation Trace Macrocell* (ITM), with separate IDs, to a data stream. The TPIU encapsulates IDs where required, and the data stream is then captured by a *Trace Port Analyzer* (TPA).

The Cortex-M4 TPIU is specially designed for low-cost debug. It is a special version of the CoreSight TPIU. Your implementation can replace the Cortex-M4 TPIU with other CoreSight components if your implementation requires the additional features of the CoreSight TPIU.

In this chapter, the term TPIU refers to the Cortex-M4 TPIU. For information about the CoreSight TPIU, see the *ARM CoreSight Components Technical Reference Manual*.



## 11.2 TPIU functional description

There are two configurations of the TPIU:

- A configuration that supports ITM debug trace.
- A configuration that supports both ITM and ETM debug trace.

If your implementation requires no trace support then the TPIU might not be present.

———— **Note** ————

If your Cortex-M4 system uses the optional ETM component, the TPIU configuration supports both ITM and ETM debug trace. See the *ETM-M4 Technical Reference Manual*.

### 11.2.1 TPIU block diagrams

Figure 11-1 shows the component layout of the TPIU for both configurations.

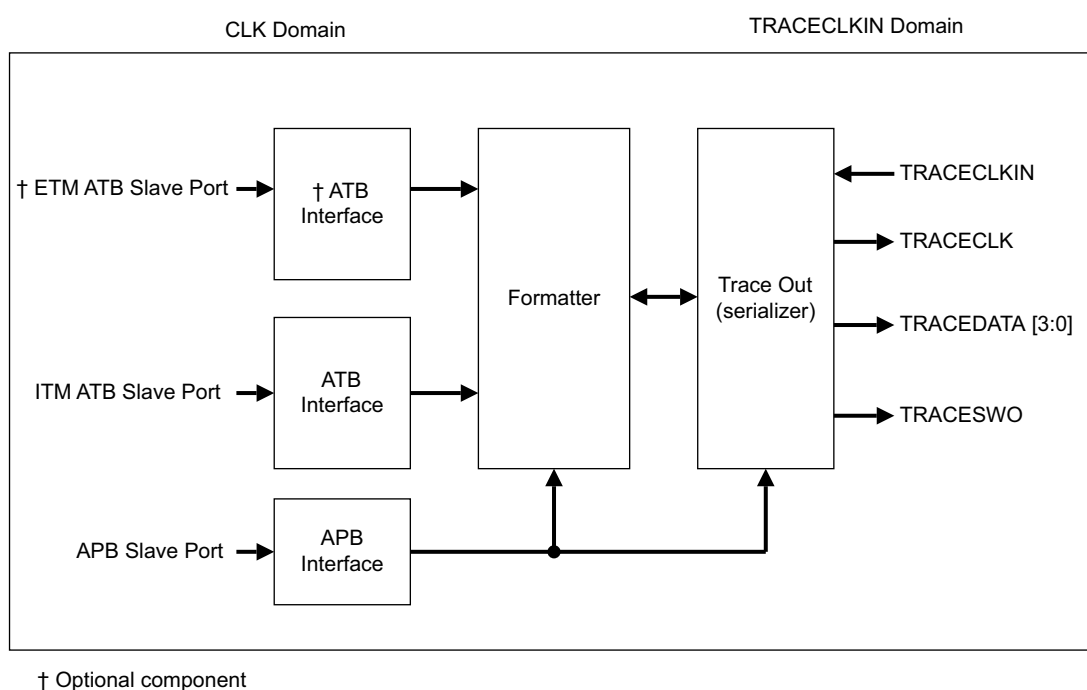

**Figure 11-1** TPIU block diagram

### 11.2.2 TPIU Formatter

The formatter inserts source ID signals into the data packet stream so that trace data can be re-associated with its trace source. The formatter is always active when the Trace Port Mode is active.

The formatting protocol is described in the *CoreSight Architecture Specification*. You must enable synchronization packets in the DWT to provide synchronization for the formatter.

When the formatter is enabled, half-sync packets may be inserted if there is no data to output after a frame has been started. Synchronization, caused by the distributed synchronization from the DWT, will ensure that any partial frame is completed, and at least one full synchronization packet will be generated.

### 11.2.3 Serial Wire Output format

The TPIU can output trace data in a *Serial Wire Output* (SWO) format:

- TPIU\_DEVID specifies the formats that are supported. See *TPIU\_DEVID* on page 11-12.
- TPIU\_SPPR specifies the SWO format in use. See the *ARMv7-M Architecture Reference Manual*.

When one of the two SWO modes is selected, you can enable the TPIU to bypass the formatter for trace output. If the formatter is bypassed, only the ITM and DWT trace source passes through. The TPIU accepts and discards data from the ETM. This function can be used to connect a device containing an ETM to a trace capture device that is only able to capture SWO data.

## 11.3 TPIU programmers model

Table 11-1 provides a summary of the TPIU registers. Depending on the implementation of your processor, the TPIU registers might not be present, or the CoreSight TPIU might be present instead. Any register that is configured as not present reads as zero.

**Table 11-1 TPIU registers**

Address	Name	Type	Reset	Description
0xE0040000	TPIU_SSPSR	RO	0x0xx	Supported Synchronous Port Size Register
0xE0040004	TPIU_CSPPSR	RW	0x01	Current Synchronous Port Size Register
0xE0040010	TPIU_ACPR	RW	0x0000	<i>Asynchronous Clock Prescaler Register; TPIU_ACPR on page 11-6</i>
0xE00400F0	TPIU_SPPR	RW	0x01	Selected Pin Protocol Register
0xE0040300	TPIU_FFSR	RO	0x08	<i>Formatter and Flush Status Register; TPIU_FFSR on page 11-6</i>
0xE0040304	TPIU_FFCR	RW	0x102	<i>Formatter and Flush Control Register; TPIU_FFCR on page 11-7</i>
0xE0040308	TPIU_FSCR	RO	0x00	Formatter Synchronization Counter Register
0xE0040EE8	TRIGGER	RO	0x0	<i>TRIGGER on page 11-8</i>
0xE0040EEC	FIFO data 0	RO	0x--000000	<i>Integration ETM Data on page 11-8</i>
0xE0040EF0	ITATBCTR2	RO	0x0	<i>ITATBCTR2 on page 11-9</i>
0xE0040EFC	FIFO data 1	RO	0x--000000	<i>Integration ITM Data on page 11-10</i>
0xE0040EF8	ITATBCTR0	RO	0x0	<i>ITATBCTR0 on page 11-11</i>
0xE0040F00	ITCTRL	RW	0x0	<i>Integration Mode Control, TPIU_ITCTRL on page 11-11</i>
0xE0040FA0	CLAIMSET	RW	0xF	Claim tag set
0xE0040FA4	CLAIMCLR	RW	0x0	Claim tag clear
0xE0040FC8	DEVID	RO	-	<i>TPIU_DEVID on page 11-12</i>
0xE0040FD0	PID4	RO	0x04	Peripheral identification registers
0xE0040FD4	PID5	RO	0x00	
0xE0040FD8	PID6	RO	0x00	
0xE0040FDC	PID7	RO	0x00	
0xE0040FE0	PID0	RO	0xA1	Component identification registers
0xE0040FE4	PID1	RO	0xB9	
0xE0040FE8	PID2	RO	0x0B	
0xE0040FEC	PID3	RO	0x00	
0xE0040FF0	CID0	RO	0x0D	Component identification registers
0xE0040FF4	CID1	RO	0x90	
0xE0040FF8	CID2	RO	0x05	
0xE0040FFC	CID3	RO	0xB1	

The following sections describe the TPIU registers whose implementation is specific to this processor. The Formatter, Integration Mode Control, and Claim Tag registers are described in the *CoreSight Components Technical Reference Manual*. Other registers are described in the *ARMv7-M Architecture Reference Manual*.

### 11.3.1 Asynchronous Clock Prescaler Register, TPIU\_ACPR

The TPIU\_ACPR characteristics are:

- Purpose** Scales the baud rate of the asynchronous output.
- Usage constraints** There are no usage constraints.
- Configurations** This register is available in all processor configurations.
- Attributes** See Table 11-1 on page 11-5.

Figure 11-2 shows the TPIU\_ACPR bit assignments.

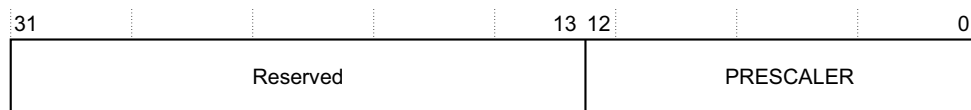

Figure 11-2 TPIU\_ACPR bit assignments

Table 11-2 shows the TPIU\_ACPR bit assignments.

Table 11-2 TPIU\_ACPR bit assignments

Bits	Name	Function
[31:13]	-	Reserved. RAZ/SBZP.
[12:0]	PRESCALER	Divisor for TRACECLKIN is Prescaler + 1.

### 11.3.2 Formatter and Flush Status Register, TPIU\_FFSR

The TPIU\_FFSR characteristics are:

- Purpose** Indicates the status of the TPIU formatter.
- Usage constraints** There are no usage constraints.
- Configurations** This register is available in all processor configurations.
- Attributes** See Table 11-1 on page 11-5.

Figure 11-3 shows the TPIU\_FFSR bit assignments.

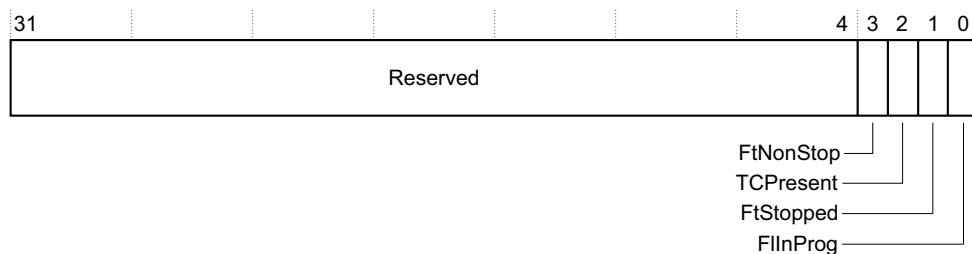

Figure 11-3 TPIU\_FFSR bit assignments

Table 11-3 shows the TPIU\_FFSR bit assignments.

**Table 11-3 TPIU\_FFSR bit assignments**

Bits	Name	Function
[31:4]	-	Reserved
[3]	FtNonStop	Formatter cannot be stopped
[2]	TCPresent	This bit always reads zero
[1]	FtStopped	This bit always reads zero
[0]	FlInProg	This bit always reads zero

### 11.3.3 Formatter and Flush Control Register, TPIU\_FFCR

The TPIU\_FFCR characteristics are:

- Purpose** Controls the TPIU formatter.
- Usage constraints** There are no usage constraints.
- Configurations** This register is available in all processor configurations.
- Attributes** See Table 11-1 on page 11-5.

Figure 11-4 shows the TPIU\_FFCR bit assignments.

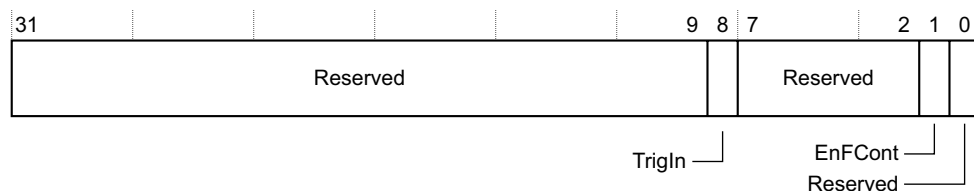

**Figure 11-4 TPIU\_FFCR bit assignments**

Table 11-4 shows the TPIU\_FFCR bit assignments.

**Table 11-4 TPIU\_FFCR bit assignments**

Bits	Name	Function
[31:9]	-	Reserved.
[8]	TrigIn	This bit Reads-As-One (RAO), specifying that triggers are inserted when a trigger pin is asserted.
[7:2]	-	Reserved.
[1]	EnFCont	Enable continuous formatting. Value can be: 0 = Continuous formatting disabled. 1 = Continuous formatting enabled.
[0]	-	Reserved.

The TPIU can output trace data in a *Serial Wire Output (SWO)* format. See *Serial Wire Output format* on page 11-4.

When one of the two SWO modes is selected, bit [1] of TPIU\_FFCR enables the formatter to be bypassed. If the formatter is bypassed, only the ITM and DWT trace source passes through. The TPIU accepts and discards data from the ETM. This function can be used to connect a device containing an ETM to a trace capture device that is only able to capture SWO data. Enabling or disabling the formatter causes momentary data corruption.

———— **Note** ————

If TPIU\_SPPR is set to select Trace Port Mode, the formatter is automatically enabled. If you then select one of the SWO modes, TPIU\_FFCR reverts to its previously programmed value.

### 11.3.4 TRIGGER

The TRIGGER characteristics are:

- Purpose** Integration test of the TRIGGER input.
- Usage constraints** There are no usage constraints.
- Configurations** This register is available in all processor configurations.
- Attributes** See Table 11-1 on page 11-5.

Figure 11-5 shows the TRIGGER bit assignments.

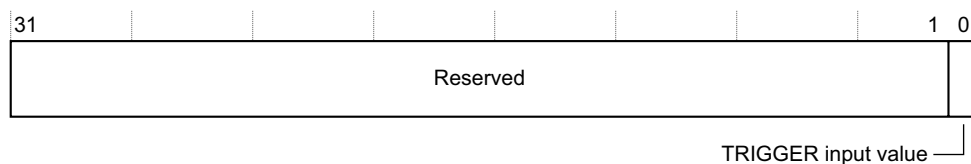

**Figure 11-5 TRIGGER bit assignments**

Table 11-5 shows the TRIGGER bit assignments.

**Table 11-5 TRIGGER bit assignments**

Bits	Name	Function
[31:1]	-	Reserved
[0]	TRIGGER input value	When read, this bit returns the TRIGGER input.

### 11.3.5 Integration ETM Data

The Integration ETM Data characteristics are:

- Purpose** Trace data integration testing.
- Usage constraints** You must set bit [1] of TPIU\_ITCTRL to use this register. See *Integration Mode Control, TPIU\_ITCTRL* on page 11-11.
- Configurations** This register is available in all processor configurations.
- Attributes** See Table 11-1 on page 11-5.

Figure 11-6 on page 11-9 shows the Integration ETM Data bit assignments.

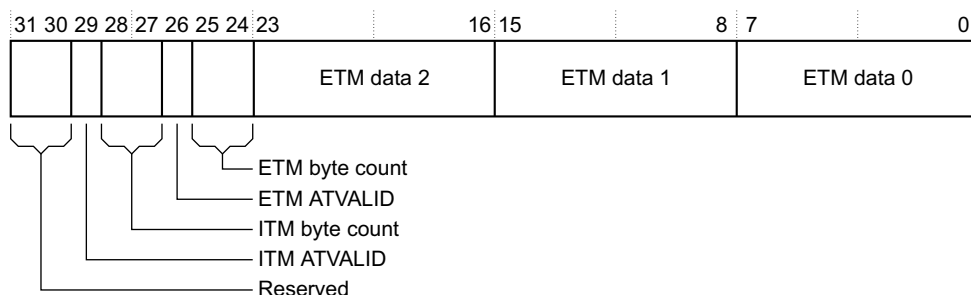

**Figure 11-6 Integration ETM Data bit assignments**

Table 11-6 shows the Integration ETM Data bit assignments.

**Table 11-6 Integration ETM Data bit assignments**

Bits	Name	Function
[31:30]	-	Reserved
[29]	ITM ATVALID input	Returns the value of the ITM ATVALID signal.
[28:27]	ITM byte count	Number of bytes of ITM trace data since last read of Integration ITM Data Register.
[26]	ETM ATVALID input	Returns the value of the ETM ATVALID signal.
[25:24]	ETM byte count	Number of bytes of ETM trace data since last read of Integration ETM Data Register.
[23:16]	ETM data 2	ETM trace data. The TPIU discards this data when the register is read.
[15:8]	ETM data 1	
[7:0]	ETM data 0	

### 11.3.6 ITATBCTR2

The ITATBCTR2 characteristics are:

**Purpose** Integration test.

**Usage constraints** You must set bit [0] of TPIU\_ITCTRL to use this register. See *Integration Mode Control, TPIU\_ITCTRL* on page 11-11.

**Configurations** This register is available in all processor configurations.

**Attributes** See Table 11-1 on page 11-5.

Figure 11-7 shows the ITATBCTR2 bit assignments.

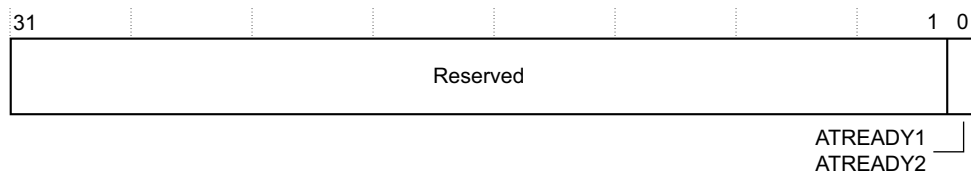

**Figure 11-7 ITATBCTR2 bit assignments**

Table 11-7 shows the ITATBCTR2 bit assignments.

**Table 11-7 ITATBCTR2 bit assignments**

Bits	Name	Function
[31:1]	-	Reserved
[0]	ATREADY1, ATREADY2	This bit sets the value of both the ETM and ITM ATREADY outputs, if the TPIU is in integration test mode.

### 11.3.7 Integration ITM Data

The Integration ITM Data characteristics are:

<b>Purpose</b>	Trace data integration testing.
<b>Usage constraints</b>	You must set bit [1] of TPIU_ITCTRL to use this register. See <i>Integration Mode Control, TPIU_ITCTRL</i> on page 11-11.
<b>Configurations</b>	This register is available in all processor configurations.
<b>Attributes</b>	See Table 11-1 on page 11-5

Figure 11-8 shows the Integration ITM Data bit assignments.

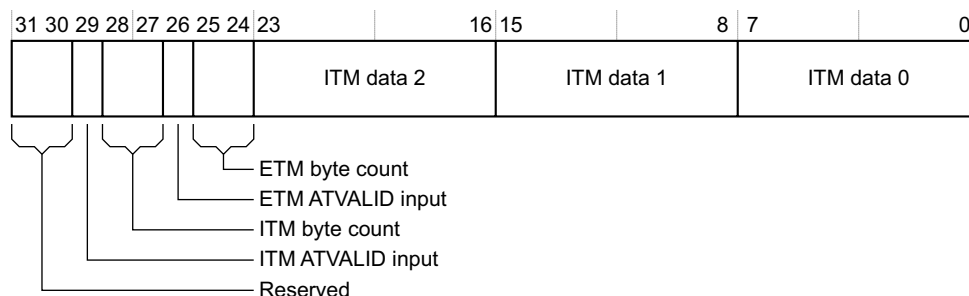

**Figure 11-8 Integration ITM Data bit assignments**

Table 11-8 shows the Integration ITM Data bit assignments.

**Table 11-8 Integration ITM Data bit assignments**

Bits	Name	Function
[31:30]	-	Reserved
[29]	ITM ATVALID input	Returns the value of the ITM ATVALID signal.
[28:27]	ITM byte count	Number of bytes of ITM trace data since last read of Integration ITM Data Register.
[26]	ETM ATVALID input	Returns the value of the ETM ATVALID signal.
[25:24]	ETM byte count	Number of bytes of ETM trace data since last read of Integration ETM Data Register.
[23:16]	ITM data 2	ITM trace data. The TPIU discards this data when the register is read.
[15:8]	ITM data 1	
[7:0]	ITM data 0	



### 11.3.8 ITATBCTR0

The ITATBCTR0 characteristics are:

- Purpose** Integration test.
- Usage constraints** There are no usage constraints.
- Configurations** This register is available in all processor configurations.
- Attributes** See Table 11-1 on page 11-5.

Figure 11-9 shows the ITATBCTR0 bit assignments.

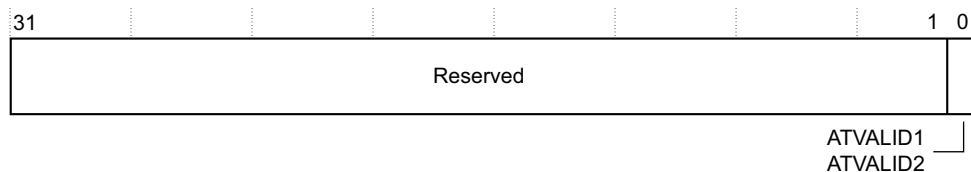

**Figure 11-9 ITATBCTR0 bit assignments**

Table 11-9 shows the ITATBCTR0 bit assignments.

**Table 11-9 ITATBCTR0 bit assignments**

Bits	Name	Function
[31:1]	-	Reserved
[0]	ATVALID1, ATVALID2	A read of this bit returns the value of ATVALIDS1 OR-ed with ATVALIDS2.

### 11.3.9 Integration Mode Control, TPIU\_ITCTRL

The TPIU\_ITCTRL characteristics are:

- Purpose** Specifies normal or integration mode for the TPIU.
- Usage constraints** There are no usage constraints.
- Configurations** This register is available in all processor configurations.
- Attributes** See Table 11-1 on page 11-5.

Figure 11-10 shows the TPIU\_ITCTRL bit assignments.

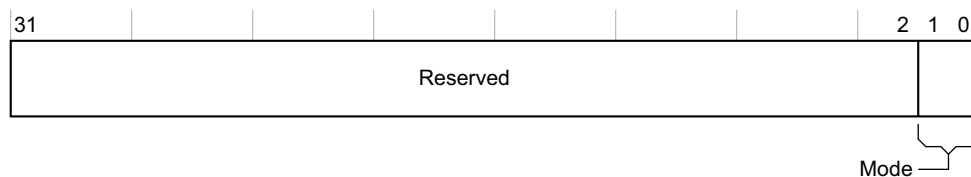

**Figure 11-10 TPIU\_ITCTRL bit assignments**

Table 11-10 shows the TPIU\_ITCTRL bit assignments.

**Table 11-10 TPIU\_ITCTRL bit assignments**

Bits	Name	Function
[31:2]	-	Reserved.
[1:0]	Mode	Specifies the current mode for the TPIU: b00 normal mode b01 integration test mode b10 integration data test mode b11 Reserved. In integration data test mode, the trace output is disabled, and data can be read directly from each input port using the integration data registers.

### 11.3.10 TPIU\_DEVID

The TPIU\_DEVID characteristics are:

**Purpose** Indicates the functions provided by the TPIU for use in topology detection.

**Usage constraints** There are no usage constraints.

**Configurations** This register is available in all processor configurations.

**Attributes** See Table 11-1 on page 11-5.

Figure 11-11 shows the TPIU\_DEVID bit assignments.

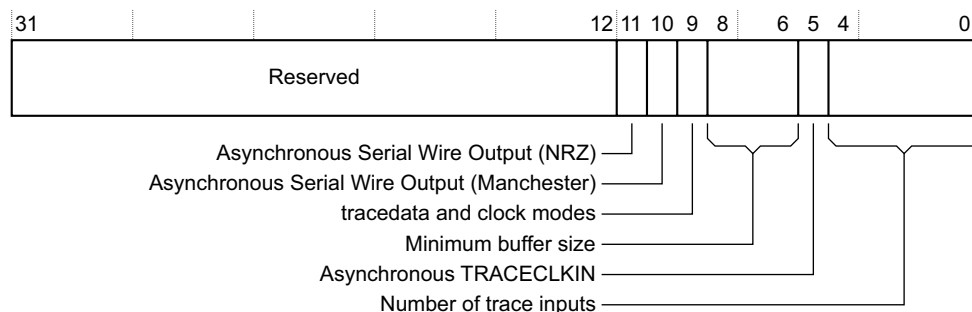

**Figure 11-11 TPIU\_DEVID bit assignments**

Table 11-11 shows the TPIU\_DEVID bit assignments.

**Table 11-11 TPIU\_DEVID bit assignments**

Bits	Name	Function
[31:12]	-	Reserved
[11]	Asynchronous Serial Wire Output (NRZ)	This bit Reads-As-One (RAO), indicating that the output is supported.
[10]	Asynchronous Serial Wire Output (Manchester)	This bit Reads-As-One (RAO), indicating that the output is supported.
[9]	Tracedata and clock modes	This bit Reads-As-Zero (RAZ), indicating that tracedata and clock modes are supported

Table 11-11 TPIU\_DEVID bit assignments (continued)

Bits	Name	Function
[8:6]	Minimum buffer size	Specifies the minimum TPIU buffer size: b010 = 4 bytes
[5]	Asynchronous <b>TRACECLKIN</b>	Specifies whether <b>TRACECLKIN</b> can be asynchronous to <b>CLK</b> b0 = <b>TRACECLKIN</b> must be synchronous to <b>CLK</b> b1 = <b>TRACECLKIN</b> can be asynchronous to <b>CLK</b>
[4:0]	Number of trace inputs	Specifies the number of trace inputs: b000000 = 1 input b000001 = 2 inputs If your implementation includes an ETM, the value of this field is b000001.

# Appendix A

## Revisions

This appendix describes the technical changes between released issues of this book.

**Table A-1 Issue A**

<b>Change</b>	<b>Location</b>	<b>Affects</b>
First release	-	-

**Table A-2 Differences between issue A and issue BC**

<b>Change</b>	<b>Location</b>	<b>Affects</b>
No technical changes	-	-

# Glossary

This glossary describes some of the terms used in technical documents from ARM.

**Abort** A mechanism that indicates to a core that the attempted memory access is invalid or not allowed or that the data returned by the memory access is invalid. An abort can be caused by the external or internal memory system as a result of attempting to access invalid or protected instruction or data memory.

*See also* Data Abort, External Abort and Prefetch Abort.

**Addressing modes** Various mechanisms, shared by many different instructions, for generating values used by the instructions.

**Advanced High-performance Bus (AHB)**

A bus protocol with a fixed pipeline between address/control and data phases. It only supports a subset of the functionality provided by the AMBA AXI protocol. The full AMBA AHB protocol specification includes a number of features that are not commonly required for master and slave IP developments and ARM recommends only a subset of the protocol is usually used. This subset is defined as the AMBA AHB-Lite protocol.

*See also* Advanced Microcontroller Bus Architecture and AHB-Lite.

**Advanced Microcontroller Bus Architecture (AMBA)**

A family of protocol specifications that describe a strategy for the interconnect. AMBA is the ARM open standard for on-chip buses. It is an on-chip bus specification that details a strategy for the interconnection and management of functional blocks that make up a *System-on-Chip* (SoC). It aids in the development of embedded processors with one or more CPUs or signal processors and multiple peripherals. AMBA complements a reusable design methodology by defining a common backbone for SoC modules.

**Advanced Peripheral Bus (APB)**

A simpler bus protocol than AXI and AHB. It is designed for use with ancillary or general-purpose peripherals such as timers, interrupt controllers, UARTs, and I/O ports. Connection to the main system bus is through a system-to-peripheral bus bridge that helps to reduce system power consumption.

**AHB** *See* Advanced High-performance Bus.

**AHB Access Port (AHB-AP)**

An optional component of the DAP that provides an AHB interface to a SoC.

**AHB-AP** *See* AHB Access Port.

**AHB-Lite**

A subset of the full AMBA AHB protocol specification. It provides all of the basic functions required by the majority of AMBA AHB slave and master designs, particularly when used with a multi-layer AMBA interconnect. In most cases, the extra facilities provided by a full AMBA AHB interface are implemented more efficiently by using an AMBA AXI protocol interface.

**AHB Trace Macrocell**

A hardware macrocell that, when connected to a processor core, outputs data trace information on a trace port.

**Aligned**

A data item stored at an address that is divisible by the number of bytes that defines the data size is said to be aligned. Aligned words and halfwords have addresses that are divisible by four and two respectively. The terms word-aligned and halfword-aligned therefore stipulate addresses that are divisible by four and two respectively.

**AMBA**

*See* Advanced Microcontroller Bus Architecture.

**Advanced Trace Bus (ATB)**

A bus used by trace devices to share CoreSight capture resources.

**APB**

*See* Advanced Peripheral Bus.

**Application Specific Integrated Circuit (ASIC)**

An integrated circuit that has been designed to perform a specific application function. It can be custom-built or mass-produced.

**Architecture**

The organization of hardware and/or software that characterizes a processor and its attached components, and enables devices with similar characteristics to be grouped together when describing their behavior, for example, Harvard architecture, instruction set architecture, ARMv7-M architecture.

**ARM instruction**

An instruction of the ARM Instruction Set Architecture (ISA). These cannot be executed by the Cortex-M4 processor.

**ARM state**

The processor state in which the processor executes the instructions of the ARM ISA. The processor only operates in Thumb state, never in ARM state.

**ASIC**

*See* Application Specific Integrated Circuit.

**ATB**

*See* Advanced Trace Bus.

**ATB bridge**

A synchronous ATB bridge provides a register slice to facilitate timing closure through the addition of a pipeline stage. It also provides a unidirectional link between two synchronous ATB domains.

An asynchronous ATB bridge provides a unidirectional link between two ATB domains with asynchronous clocks. It is intended to support connection of components with ATB ports residing in different clock domains.

<b>Base register</b>	A register specified by a load or store instruction that is used to hold the base value for the instruction's address calculation. Depending on the instruction and its addressing mode, an offset can be added to or subtracted from the base register value to form the address that is sent to memory.
<b>Base register write-back</b>	Updating the contents of the base register used in an instruction target address calculation so that the modified address is changed to the next higher or lower sequential address in memory. This means that it is not necessary to fetch the target address for successive instruction transfers and enables faster burst accesses to sequential memory.
<b>Beat</b>	Alternative word for an individual data transfer within a burst. For example, an INCR4 burst comprises four beats.
<b>BE-8</b>	Big-endian view of memory in a byte-invariant system. <i>See also</i> BE-32, LE, Byte-invariant and Word-invariant.
<b>BE-32</b>	Big-endian view of memory in a word-invariant system. <i>See also</i> BE-8, LE, Byte-invariant and Word-invariant.
<b>Big-endian</b>	Byte ordering scheme in which bytes of decreasing significance in a data word are stored at increasing addresses in memory.  <i>See also</i> Little-endian and Endianness.
<b>Big-endian memory</b>	Memory in which: <ul style="list-style-type: none"> <li>• a byte or halfword at a word-aligned address is the most significant byte or halfword within the word at that address</li> <li>• a byte at a halfword-aligned address is the most significant byte within the halfword at that address.</li> </ul> <i>See also</i> Little-endian memory.
<b>Boundary scan chain</b>	A boundary scan chain is made up of serially-connected devices that implement boundary scan technology using a standard JTAG TAP interface. Each device contains at least one TAP controller containing shift registers that form the chain connected between <b>TDI</b> and <b>TDO</b> , through which test data is shifted. Processors can contain several shift registers to enable you to access selected parts of the device.
<b>Branch folding</b>	Branch folding is a technique where the branch instruction is completely removed from the instruction stream presented to the execution pipeline.
<b>Breakpoint</b>	A breakpoint is a mechanism provided by debuggers to identify an instruction at which program execution is to be halted. Breakpoints are inserted by the programmer to enable inspection of register contents, memory locations, variable values at fixed points in the program execution to test that the program is operating correctly. Breakpoints are removed after the program is successfully tested.  <i>See also</i> Watchpoint.
<b>Burst</b>	A group of transfers to consecutive addresses. Because the addresses are consecutive, there is no requirement to supply an address for any of the transfers after the first one. This increases the speed at which the group of transfers can occur. Bursts over AMBA are controlled using signals to indicate the length of the burst and how the addresses are incremented.  <i>See also</i> Beat.

<b>Byte</b>	An 8-bit data item.
<b>Byte-invariant</b>	<p>In a byte-invariant system, the address of each byte of memory remains unchanged when switching between little-endian and big-endian operation. When a data item larger than a byte is loaded from or stored to memory, the bytes making up that data item are arranged into the correct order depending on the endianness of the memory access. The ARM architecture supports byte-invariant systems in ARMv6 and later versions. When byte-invariant support is selected, unaligned halfword and word memory accesses are also supported. Multi-word accesses are expected to be word-aligned.</p> <p><i>See also</i> Word-invariant.</p>
<b>Clock gating</b>	Gating a clock signal for a macrocell with a control signal and using the modified clock that results to control the operating state of the macrocell.
<b>Clocks Per Instruction (CPI)</b>	<i>See</i> Cycles Per Instruction (CPI).
<b>Cold reset</b>	<p>Also known as power-on reset.</p> <p><i>See also</i> Warm reset.</p>
<b>Context</b>	<p>The environment that each process operates in for a multitasking operating system.</p> <p><i>See also</i> Fast context switch.</p>
<b>Core</b>	A core is that part of a processor that contains the ALU, the datapath, the general-purpose registers, the Program Counter, and the instruction decode and control circuitry.
<b>Core reset</b>	<i>See</i> Warm reset.
<b>CoreSight</b>	The infrastructure for monitoring, tracing, and debugging a complete system on chip.
<b>CPI</b>	<i>See</i> Cycles per instruction.
<b>Cycles Per instruction (CPI)</b>	<p>Cycles per instruction (or clocks per instruction) is a measure of the number of computer instructions that can be performed in one clock cycle. This figure of merit can be used to compare the performance of different CPUs that implement the same instruction set against each other. The lower the value, the better the performance.</p>
<b>Data Abort</b>	<p>An indication from a memory system to the core of an attempt to access an illegal data memory location. An exception must be taken if the processor attempts to use the data that caused the abort.</p> <p><i>See also</i> Abort.</p>
<b>DCode Memory</b>	Memory space at 0x00000000 to 0x1FFFFFFF.
<b>Debug Access Port (DAP)</b>	A TAP block that acts as an AMBA, AHB or AHB-Lite, master for access to a system bus. The DAP is the term used to encompass a set of modular blocks that support system wide debug. The DAP is a modular component, intended to be extendable to support optional access to multiple systems such as memory mapped AHB and CoreSight APB through a single debug interface.
<b>Debugger</b>	A debugging system that includes a program, used to detect, locate, and correct software faults, together with custom hardware that supports software debugging.
<b>Embedded Trace Buffer</b>	The ETB provides on-chip storage of trace data using a configurable sized RAM.



**Embedded Trace Macrocell (ETM)**

A hardware macrocell that, when connected to a processor core, outputs instruction trace information on a trace port.

**Endianness**

Byte ordering. The scheme that determines the order that successive bytes of a data word are stored in memory. An aspect of the system's memory mapping.

*See also* Little-endian and Big-endian

**ETB**

*See* Embedded Trace Buffer.

**ETM**

*See* Embedded Trace Macrocell.

**Exception**

An error or event which can cause the processor to suspend the currently executing instruction stream and execute a specific exception handler or interrupt service routine. The exception could be an external interrupt or NMI, or it could be a fault or error event that is considered serious enough to require that program execution is interrupted. Examples include attempting to perform an invalid memory access, external interrupts, and undefined instructions. When an exception occurs, normal program flow is interrupted and execution is resumed at the corresponding exception vector. This contains the first instruction of the interrupt service routine to deal with the exception.

**Exception handler**

*See* Interrupt service routine.

**Exception vector**

*See* Interrupt vector.

**External PPB**

PPB memory space at 0xE0040000 to 0xE00FFFFF.

**Flash Patch and Breakpoint unit (FPB)**

A set of address matching tags, that reroute accesses into flash to a special part of SRAM. This permits patching flash locations for breakpointing and quick fixes or changes.

**Formatter**

The formatter is an internal input block in the ETB and TPIU that embeds the trace source ID within the data to create a single trace stream.

**Halfword**

A 16-bit data item.

**Halt mode**

One of two mutually exclusive debug modes. In halt mode all processor execution halts when a breakpoint or watchpoint is encountered. All processor state, coprocessor state, memory and input/output locations can be examined and altered by the JTAG interface.

*See also* Monitor debug-mode.

**Host**

A computer that provides data and other services to another computer. Especially, a computer providing debugging services to a target being debugged.

**HTM**

*See* AHB Trace Macrocell.

**ICode Memory**

Memory space at 0x00000000 to 0x1FFFFFFF.

**Illegal instruction**

An instruction that is architecturally Undefined.

**Implementation-defined**

The behavior is not architecturally defined, but is defined and documented by individual implementations.

**Implementation-specific**

The behavior is not architecturally defined, and does not have to be documented by individual implementations. Used when there are a number of implementation options available and the option chosen does not affect software compatibility.

<b>Instruction cycle count</b>	The number of cycles for which an instruction occupies the Execute stage of the pipeline.
<b>Instrumentation trace</b>	A component for debugging real-time systems through a simple memory-mapped trace interface, providing printf style debugging.
<b>Intelligent Energy Management (IEM)</b>	A technology that enables dynamic voltage scaling and clock frequency variation to be used to reduce power consumption in a device.
<b>Internal PPB</b>	PPB memory space at 0xE0000000 to 0xE003FFFF.
<b>Interrupt service routine</b>	A program that control of the processor is passed to when an interrupt occurs.
<b>Interrupt vector</b>	One of a number of fixed addresses in low memory that contains the first instruction of the corresponding interrupt service routine.
<b>Joint Test Action Group (JTAG)</b>	The name of the organization that developed standard IEEE 1149.1. This standard defines a boundary-scan architecture used for in-circuit testing of integrated circuit devices. It is commonly known by the initials JTAG.
<b>JTAG</b>	<i>See</i> Joint Test Action Group.
<b>JTAG Debug Port (JTAG-DP)</b>	An optional external interface for the DAP that provides a standard JTAG interface for debug access.
<b>JTAG-DP</b>	<i>See</i> JTAG Debug Port.
<b>LE</b>	Little-endian view of memory in both byte-invariant and word-invariant systems. <i>See also</i> Byte-invariant, Word-invariant.
<b>Little-endian</b>	Byte ordering scheme in which bytes of increasing significance in a data word are stored at increasing addresses in memory.  <i>See also</i> Big-endian and Endianness.
<b>Little-endian memory</b>	Memory in which: <ul style="list-style-type: none"> <li>• a byte or halfword at a word-aligned address is the least significant byte or halfword within the word at that address</li> <li>• a byte at a halfword-aligned address is the least significant byte within the halfword at that address.</li> </ul> <i>See also</i> Big-endian memory.
<b>Load/store architecture</b>	A processor architecture where data-processing operations only operate on register contents, not directly on memory contents.
<b>Load Store Unit (LSU)</b>	The part of a processor that handles load and store transfers.
<b>LSU</b>	<i>See</i> Load Store Unit.
<b>Macrocell</b>	A complex logic block with a defined interface and behavior. A typical VLSI system comprises several macrocells (such as a processor, an ETM, and a memory block) plus application-specific logic.

<b>Memory coherency</b>	A memory is coherent if the value read by a data read or instruction fetch is the value that was most recently written to that location. Memory coherency is made difficult when there are multiple possible physical locations that are involved, such as a system that has main memory, a write buffer and a cache.
<b>Memory Protection Unit (MPU)</b>	Hardware that controls access permissions to blocks of memory. Unlike an MMU, an MPU does not modify addresses.
<b>Microprocessor</b>	<i>See</i> Processor.
<b>Monitor debug-mode</b>	One of two mutually exclusive debug modes. In Monitor debug-mode the processor enables a software abort handler provided by the debug monitor or operating system debug task. When a breakpoint or watchpoint is encountered, this enables vital system interrupts to continue to be serviced while normal program execution is suspended.  <i>See also</i> Halt mode.
<b>MPU</b>	<i>See</i> Memory Protection Unit.
<b>Multi-layer</b>	An interconnect scheme similar to a cross-bar switch. Each master on the interconnect has a direct link to each slave, The link is not shared with other masters. This enables each master to process transfers in parallel with other masters. Contention only occurs in a multi-layer interconnect at a payload destination, typically the slave.
<b>Nested Vectored Interrupt Controller (NVIC)</b>	Provides the processor with configurable interrupt handling abilities.
<b>NMI</b>	<i>See</i> Non-maskable interrupt
<b>Non-maskable interrupt</b>	<i>A Non-Maskable Interrupt (NMI) can be signalled by a peripheral or triggered by software. This is the highest priority exception other than reset. It is permanently enabled and has a fixed priority of -2. NMIs cannot be:</i> <ul style="list-style-type: none"> <li>• masked or prevented from activation by any other exception</li> <li>• preempted by any exception other than Reset.</li> </ul>
<b>NVIC</b>	<i>See</i> Nested Vectored Interrupt Controller.
<b>Penalty</b>	The number of cycles in which no useful Execute stage pipeline activity can occur because an instruction flow is different from that assumed or predicted.
<b>PFU</b>	<i>See</i> Prefetch Unit.
<b>PMU</b>	<i>See</i> Power Management Unit.
<b>Power Management Unit (PMU)</b>	Provides the processor with power management capability.
<b>Power-on reset</b>	<i>See</i> Cold reset.
<b>PPB</b>	<i>See</i> Private Peripheral Bus.
<b>Prefetching</b>	In pipelined processors, the process of fetching instructions from memory to fill up the pipeline before the preceding instructions have finished executing. Prefetching an instruction does not mean that the instruction has to be executed.

<b>Prefetch Abort</b>	An indication from a memory system to the core that an instruction has been fetched from an illegal memory location. An exception must be taken if the processor attempts to execute the instruction. A Prefetch Abort can be caused by the external or internal memory system as a result of attempting to access invalid instruction memory.  <i>See also</i> Data Abort, Abort.
<b>Prefetch Unit (PFU)</b>	The PFU fetches instructions from the memory system that can supply one word each cycle. The PFU buffers up to three word fetches in its FIFO, which means that it can buffer up to three 32-bit Thumb instructions or six 16-bit Thumb instructions.
<b>Private Peripheral Bus</b>	Memory space at 0xE0000000 to 0xE00FFFFF.
<b>Processor</b>	A processor is the circuitry in a computer system required to process data using the computer instructions. It is an abbreviation of microprocessor. A clock source, power supplies, and main memory are also required to create a minimum complete working computer system.
<b>RW1C</b>	Register bits marked RW1C can be read normally and support write-one-to-clear. A read then write of the result back to the register will clear all bits set. RW1C protects against read-modify-write errors occurring on bits set between reading the register and writing the value back (since they are written as zero, they will not be cleared).
<b>RealView ICE</b>	A system for debugging embedded processor cores using a JTAG interface.
<b>Reserved</b>	A field in a control register or instruction format is reserved if the field is to be defined by the implementation, or produces Unpredictable results if the contents of the field are not zero. These fields are reserved for use in future extensions of the architecture or are implementation-specific. All reserved bits not used by the implementation must be written as 0 and read as 0.
<b>Scan chain</b>	A scan chain is made up of serially-connected devices that implement boundary scan technology using a standard JTAG TAP interface. Each device contains at least one TAP controller containing shift registers that form the chain connected between <b>TDI</b> and <b>TDO</b> , through which test data is shifted. Processors can contain several shift registers to enable you to access selected parts of the device.
<b>Serial-Wire Debug Port</b>	An optional external interface for the DAP that provides a serial-wire bidirectional debug interface.
<b>Serial-Wire JTAG Debug Port</b>	A standard debug port that combines JTAG-DP and SW-DP.
<b>SW-DP</b>	<i>See</i> Serial-Wire Debug Port.
<b>SWJ-DP</b>	<i>See</i> Serial-Wire JTAG Debug Port.
<b>Synchronization primitive</b>	The memory synchronization primitive instructions are those instructions that are used to ensure memory synchronization. That is, the LDREX and STREX instructions.
<b>System memory</b>	Memory space at 0x20000000 to 0xFFFFFFFF, excluding PPB space at 0xE0000000 to 0xE00FFFFF.
<b>TAP</b>	<i>See</i> Test access port.
<b>Test Access Port (TAP)</b>	The collection of four mandatory and one optional terminals that form the input/output and control interface to a JTAG boundary-scan architecture. The mandatory terminals are <b>TDI</b> , <b>TDO</b> , <b>TMS</b> , and <b>TCK</b> . The optional terminal is <b>TRST</b> . This signal is mandatory in ARM cores because it is used to reset the debug logic.

<b>Thread Control Block</b>	A data structure used by an operating system kernel to maintain information specific to a single thread of execution.
<b>Thumb instruction</b>	A halfword that specifies an operation for an ARM processor in Thumb state to perform. Thumb instructions must be halfword-aligned.
<b>Thumb state</b>	A processor that is executing Thumb (16-bit) halfword aligned instructions is operating in Thumb state.
<b>TPA</b>	See <i>Trace Port Analyzer</i> .
<b>TPIU</b>	See <i>Trace Port Interface Unit</i> .
<b>Trace Port Analyzer (TPA)</b>	A hardware device that captures trace information output on a trace port. This can be a low-cost product designed specifically for trace acquisition, or a logic analyzer.
<b>Trace Port Interface Unit (TPIU)</b>	Drains trace data and acts as a bridge between the on-chip trace data and the data stream captured by a TPA.
<b>Unaligned</b>	A data item stored at an address that is not divisible by the number of bytes that defines the data size is said to be unaligned. For example, a word stored at an address that is not divisible by four.
<b>Wake-up Interrupt Controller (WIC)</b>	The Wake-up Interrupt Controller provides significantly reduced gate count interrupt detection and prioritization logic.
<b>Warm reset</b>	Also known as a core reset. Initializes the majority of the processor excluding the debug controller and debug logic. This type of reset is useful if you are using the debugging features of a processor.
<b>Watchpoint</b>	A watchpoint is a mechanism provided by debuggers to halt program execution when the data contained by a particular memory address is changed. Watchpoints are inserted by the programmer to enable inspection of register contents, memory locations, and variable values when memory is written to test that the program is operating correctly. Watchpoints are removed after the program is successfully tested. <i>See also</i> Breakpoint.
<b>WIC</b>	See <i>Wake-up Interrupt Controller</i> .
<b>Word</b>	A 32-bit data item.
<b>Word-invariant</b>	<p>In a word-invariant system, the address of each byte of memory changes when switching between little-endian and big-endian operation, in such a way that the byte with address A in one endianness has address A EOR 3 in the other endianness. As a result, each aligned word of memory always consists of the same four bytes of memory in the same order, regardless of endianness. The change of endianness occurs because of the change to the byte addresses, not because the bytes are rearranged.</p> <p>The ARM architecture supports word-invariant systems in ARMv3 and later versions. When word-invariant support is selected, the behavior of load or store instructions that are given unaligned addresses is instruction-specific, and is in general not the expected behavior for an unaligned access. It is recommended that word-invariant systems use the endianness that produces the required byte addresses at all times, apart possibly from very early in their reset handlers before they have set up the endianness, and that this early part of the reset handler must use only aligned word memory accesses.</p> <p><i>See also</i> Byte-invariant.</p>
<b>Write buffer</b>	A pipeline stage for buffering write data to prevent bus stalls from stalling the processor.